

NOTES: THIS DRAWING IS NOT TO SCALE. CHARACTERISTICS AND DIMENSIONS OF FINISHED PRODUCT MAY VARY.
 NOTES:
 1.) ROLL CAGE 5 1/2 FROM INSIDE OF REAR GUTTER. CRASH RAIL 66" FROM FLOOR.
 2.) ALL 9x7 LIGHTS TO BE WHELEN 900 SERIES LIGHTS.

3				
2				
1	PRODUCTION DRAFT		SAH	
Rev. #	Revision Description	Date	Rev'd	App'vd

Stock/Job#:	Drawing# :	Cust. App'v/Date :	Deel. App'v/Date :
Dealer:	23-2-TRAVOIS-100		
End Customer:	TWINRIDGE ROAD		
	P.O. BOX 718		
	LINN, MO. 63051		
Osage Industries, Inc.			
DRAWING DESCRIPTION:			
EXTERIOR LAYOUT			
TYPE-II TRANSIT			
Drawn By:	S.A.H.	Date:	11-15-21
Scale: NOT TO SCALE			
Revision# : 1			

NOTICE
 This drawing and/or the information hereon is the exclusive property of Osage Industries and shall not be reproduced, used or disclosed without the authorized written consent of Osage Industries.

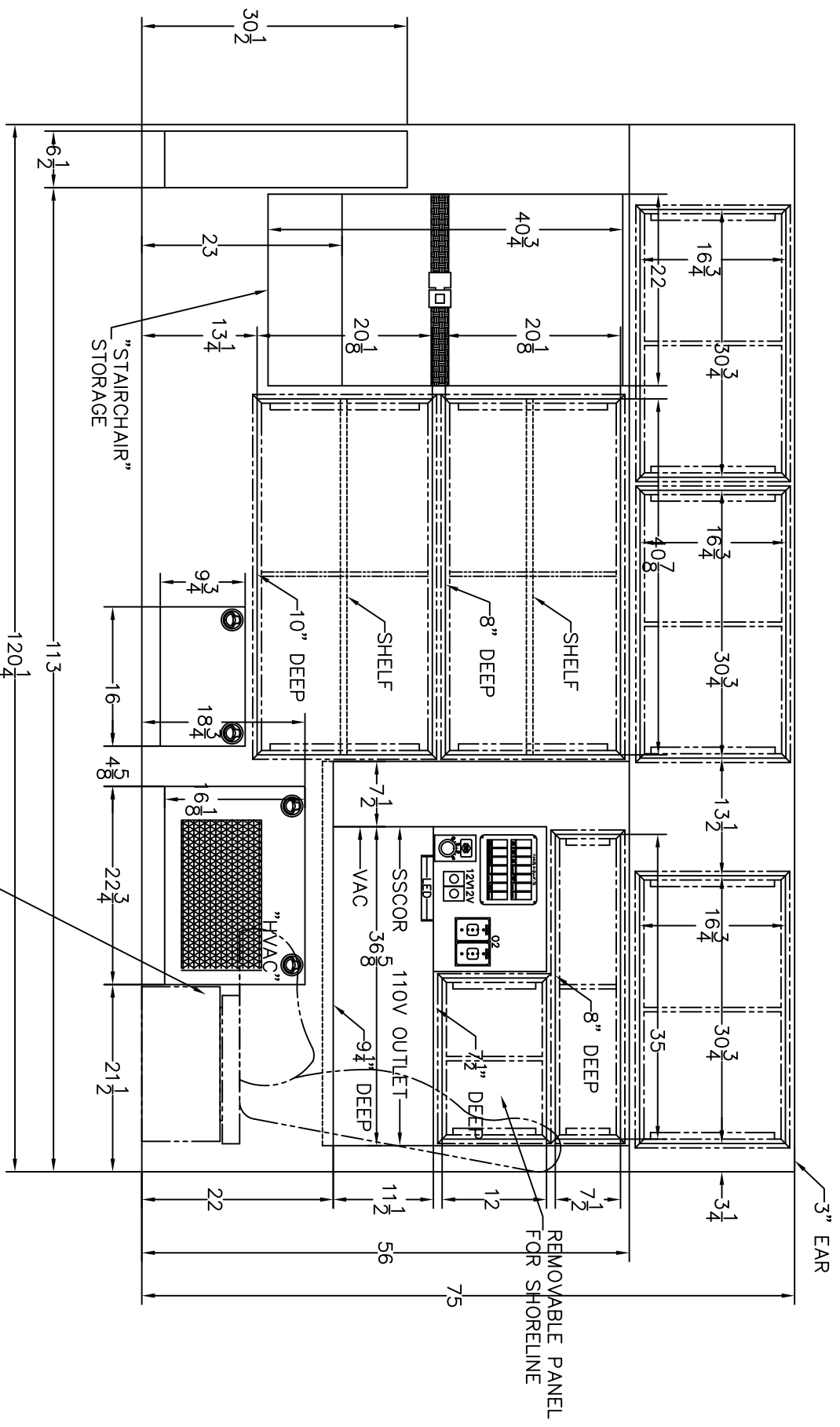

NOTES: THIS DRAWING IS NOT TO SCALE. CHARACTERISTICS AND DIMENSIONS OF FINISHED PRODUCT MAY VARY.
 NOTES: CABINET DEPTHS REPRESENT DIMENSION FROM INSIDE REAR TO FRONT FACE OF CABINETS, WITHOUT TRIM. ACTUAL WORKING DEPTH WILL BE LESS THAN DIMENSION SHOWN UNLESS OTHERWISE SPECIFIED.

3				
2				
1	PRODUCTION DRAFT		SAH	
Rev. #	Revision Description	Date	Rev'd	App'vd

Stock/Job #: _____
 Dealer: _____
 End Customer: _____

Drawing#: 23-2-TRAVOIS-101
 Cust. App'v/Date: _____
 Deal. App'v/Date: _____

Osage Industries, Inc.
 TWIN RIDGE ROAD
 P.O. BOX 718
 LINN, MO. 65051

Drawn By: S.A.H. Date: 11-15-21
 Scale: NOT TO SCALE

Drawing Description: STREETSIDE INTERIOR TYPE-II TRANSIT

Revision #: 1

NOTICE

This drawing and/or the information hereon is the exclusive property of Osage Industries and shall not be reproduced, used or disclosed without the authorized written consent of Osage Industries.

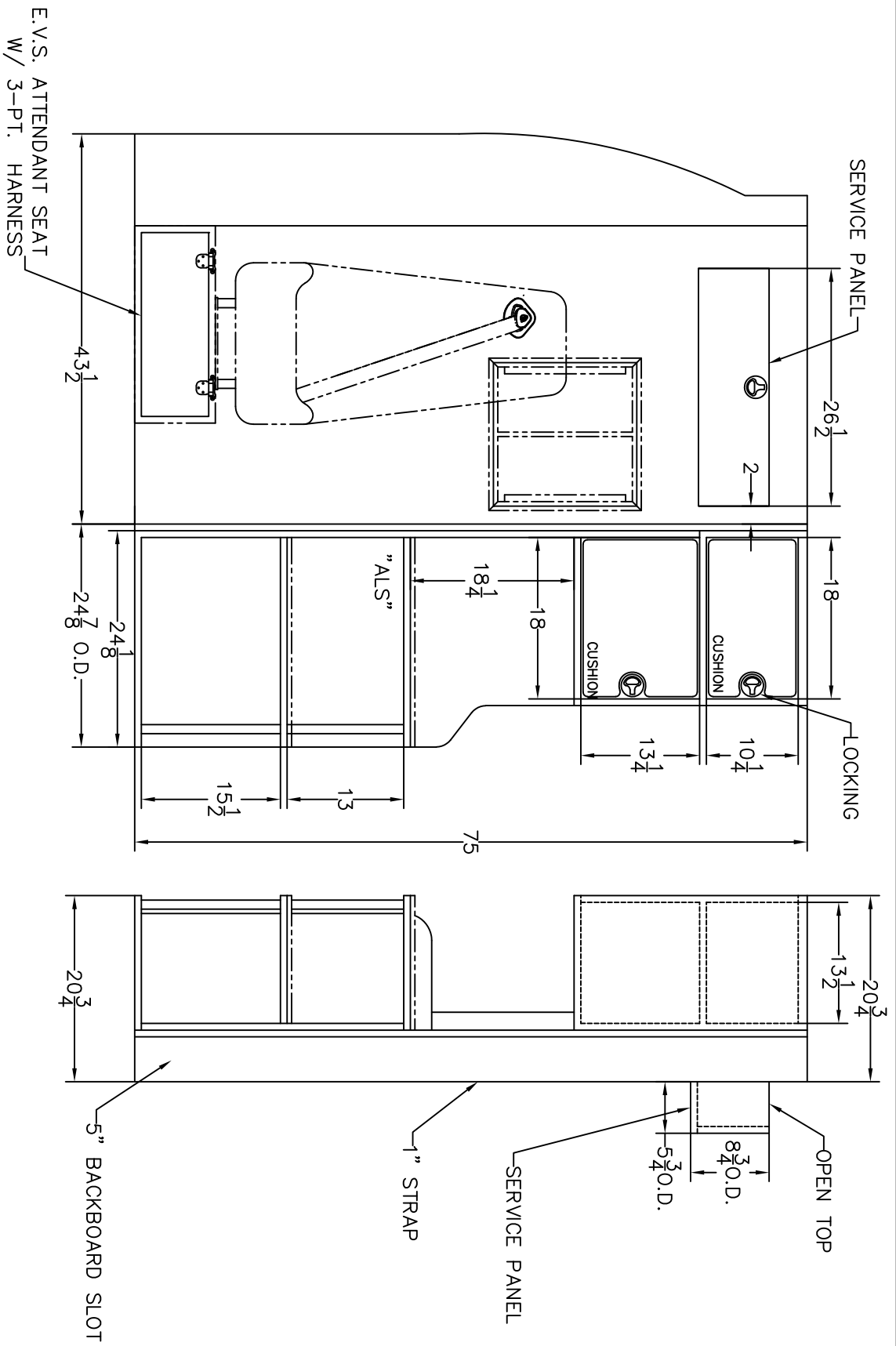

NOTES: THIS DRAWING IS NOT TO SCALE.
 CHARACTERISTICS AND DIMENSIONS OF FINISHED
 PRODUCT MAY VARY.

3				
2				
1	PRODUCTION DRAFT	SAH		
Rev. #	Revision Description	Date	Rev'd	App'vd

Stock/Job#:	Drawing#:	Cust. App'v/Date:	Devl. App'v/Date:
.	23-2-TRAVOIS-102	.	.
Dealer:	End Customer:	Drawn By:	Date:
.	TWINRIDGE ROAD	S.A.H.	11-15-21
Osage Industries, Inc. P.O. BOX 718 LINN, MO. 65051			
NOTICE This drawing and/or the information hereon is the exclusive property of Osage Industries and shall not be reproduced, used or disclosed without the authorized written consent of Osage Industries.		Drawing Description: FORWARD INTERIOR TYPE-II TRANSIT	
Scale:			Revision#:
NOT TO SCALE			1

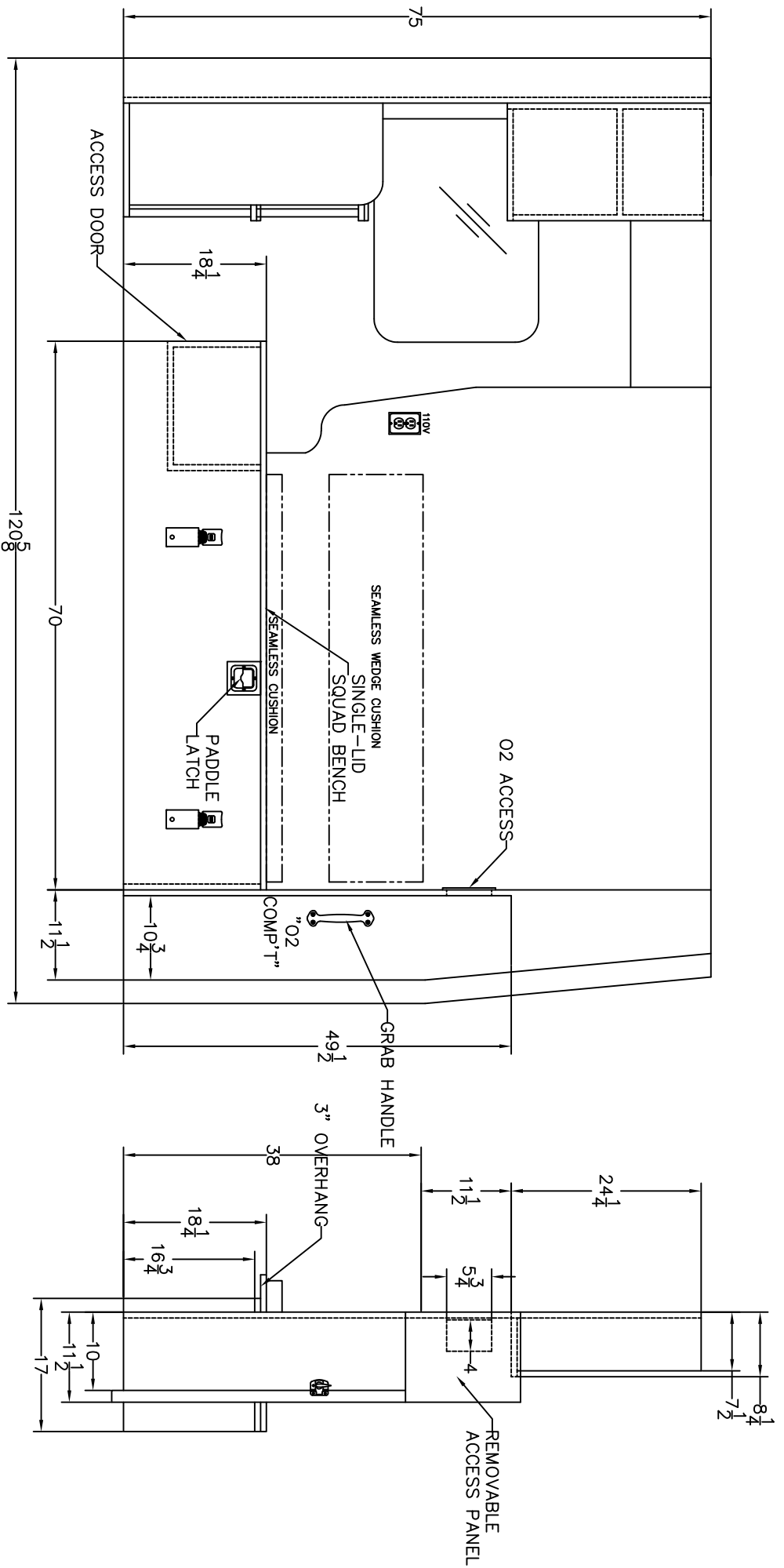

NOTES: THIS DRAWING IS NOT TO SCALE.
 CHARACTERISTICS AND DIMENSIONS OF FINISHED PRODUCT MAY VARY.

3									
2									
1									
Rev. #	Revision Description	Date	Rev'd	App'vd	Stock/Job#:	Drawing# :	Cust. App'v/Date :	Deal. App'v/Date :	
	PRODUCTION DRAFT		SAH		23-2-TRAVOIS-103	TWINRIDGE ROAD			
					End Customer:	Osage Industries, Inc.			
					Drawn By:	P.O. BOX 718			
					NOTICE	LINN, MO. 65051			
					This drawing and/or the information hereon is the exclusive property of Osage Industries and shall not be reproduced, used or disclosed without the authorized written consent of Osage Industries.				
					Drawing Description:	CURBSIDE INTERIOR TYPE-II (TRANSIT)			
					Date:	11-15-21			
					Scale:	NOT TO SCALE			
					Revision# :	1			

"STREETSIDE"

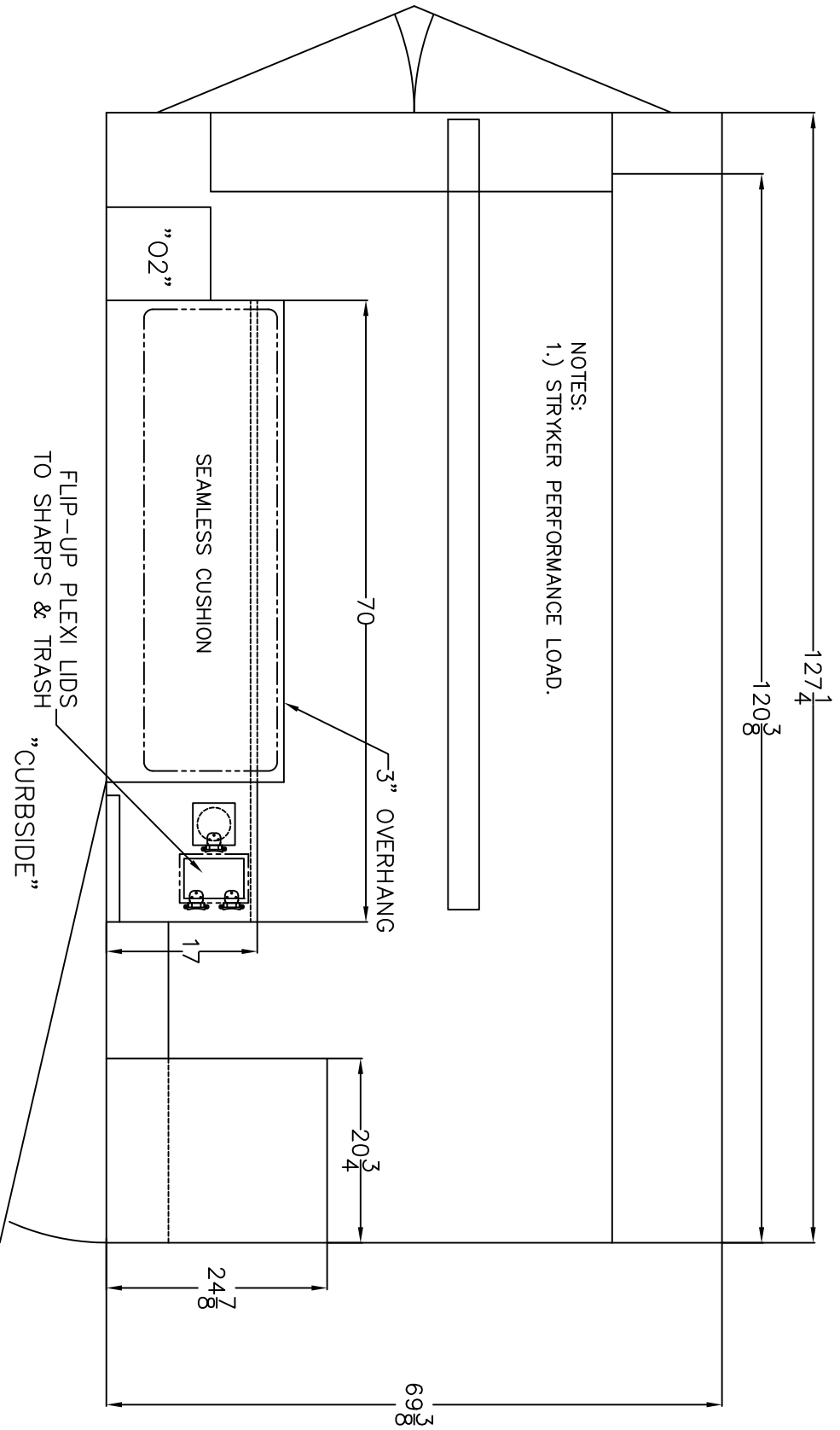

NOTES: THIS DRAWING IS NOT TO SCALE.
CHARACTERISTICS AND DIMENSIONS OF FINISHED PRODUCT MAY VARY.

3				
2				
1	PRODUCTION DRAFT		SAH	
Rev. #	Revision Description	Date	Rev'd	App'vd

Stock/Job#:	Drawing#:	Cust. App'v/Date:	Deal. App'v/Date:
Dealer:	23-2-TRAVOIS-104		
End Customer:	TWINRIDGE ROAD		
	Osage Industries, Inc.		
	P.O. BOX 718		
	LINN, MO. 65051		
Drawn By:	S.A.H.	Date:	11-15-21
Scale:	NOT TO SCALE		
Drawing Description:	FLOOR LAYOUT TYPE-II TRANSIT		
Revision#:	1		
<p>NOTICE</p> <p>This drawing and/or the information hereon is the exclusive property of Osage Industries and shall not be reproduced, used or disclosed without the authorized written consent of Osage Industries.</p>			

"STREETSIDE"

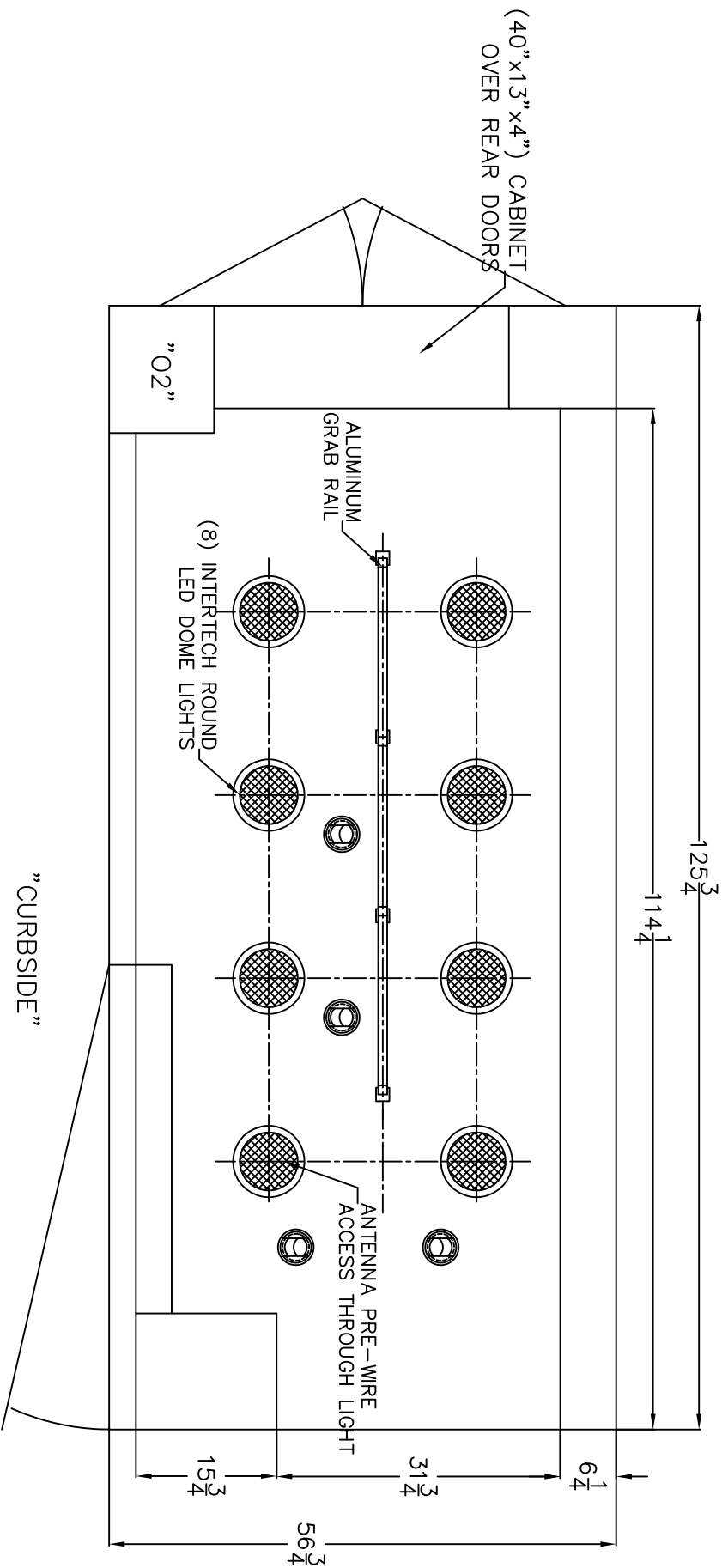

NOTES: THIS DRAWING IS NOT TO SCALE.
 CHARACTERISTICS AND DIMENSIONS OF FINISHED PRODUCT MAY VARY.

3				
2				
1	PRODUCTION DRAFT		SAH	
Rev. #	Revision Description	Date	Rev'd	App'vd

Stock/Job#:	Drawing# :	Cust. App'v/Date :	Deal. App'v/Date :
Dealer:	23-2-TRAVOIS-105		
End Customer:			
NOTICE			
This drawing and/or the information hereon is the exclusive property of Osage Industries and shall not be reproduced, used or disclosed without the authorized written consent of Osage Industries.			
Drawn By:	S.A.H.	Date:	11-15-21
Drawing Description:	CEILING LAYOUT TYPE-II TRANSIT		
Scale:	NOT TO SCALE		
Revision# :	1		

Osage Industries, Inc.
 TWINRIDGE ROAD P.O. BOX 718
 LINN, MO. 65051

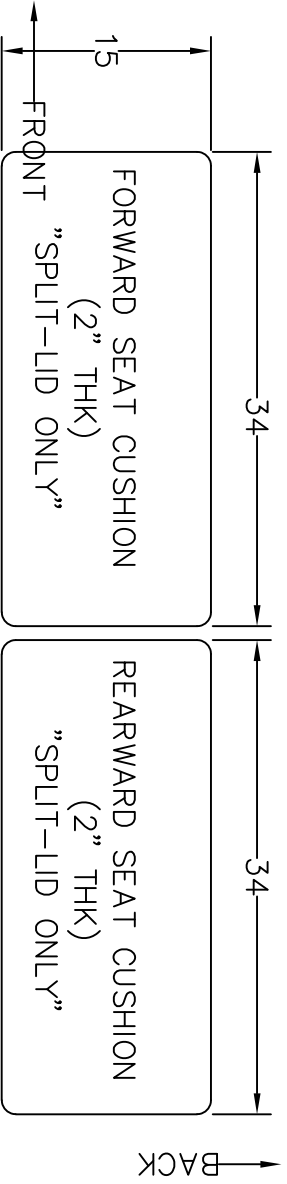
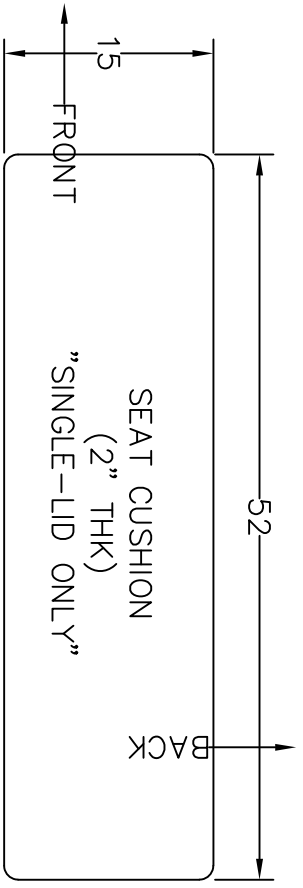
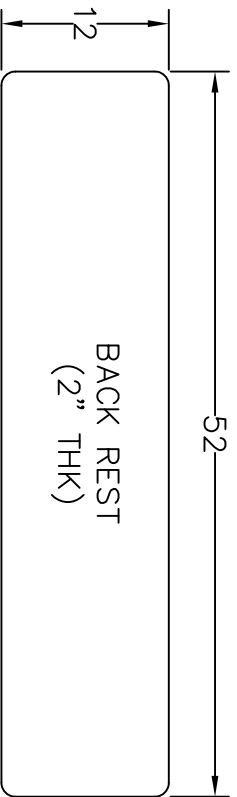

NOTES: THIS DRAWING IS NOT TO SCALE.
 CHARACTERISTICS AND DIMENSIONS OF FINISHED
 PRODUCT MAY VARY.

Stock/Job#:	Drawing#:	Cust. App'v/Date#:	Deal'r App'v/Date:
Osage Dealer:	23-2-KRAVOIS-107		
End Customer:	TWINRIDGE ROAD		
	Osage Industries, Inc.		
	P.O. BOX 718		
	LINN, MO. 63051		
NOTICE	Drawn By: S.A.H.	Date: 11-15-21	Scale: NOT TO SCALE
This drawing and/or the information hereon is the exclusive property of Osage Industries and shall not be reproduced, used or disclosed without the authorized written consent of Osage Industries.	Drawing Description:	E.V.S. SEAMLESS CUSHIONS SQUAD BENCH, TRANSIT	
Revision #	Revision Description	Date	Rev'd App'vd
3			
2			
1			
1			

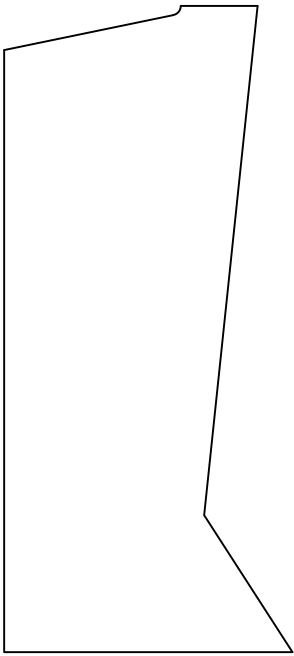
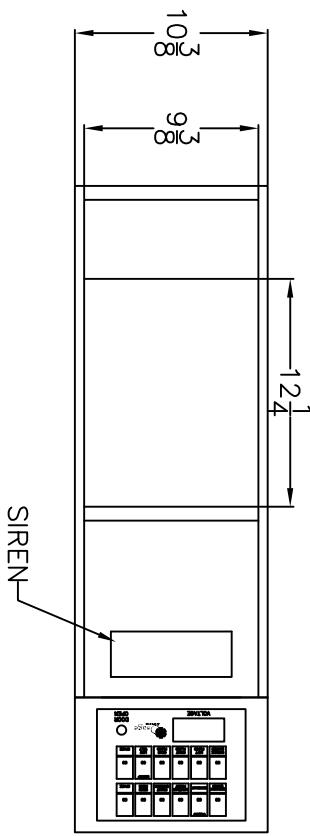

NOTES: THIS DRAWING IS NOT TO SCALE.
 CHARACTERISTICS AND DIMENSIONS OF FINISHED
 PRODUCT MAY VARY.

3			
2			
1			
Rev.#	Revision Description	Date	Rev'd App'vd

Stock/Job#:	Drawing#	Cust. App'v/Date#	Deal'r App'v/Date:
Osage Dealer:	23-2-KRAVOIS-107		
End Customer:	Osage Industries, Inc. TWINRIDGE ROAD P.O. BOX 718 LINN, MO. 63051		
NOTICE This drawing and/or the information hereon is the exclusive property of Osage Industries and shall not be reproduced, used or disclosed without the authorized written consent of Osage Industries.			
Drawn By:	Date:	Scale:	
S.A.H.	11-15-21	NOT TO SCALE	
Drawing Description:			Revision#
CONSOLE DRAWING, TRANSIT			1