

NOTES: THIS DRAWING IS NOT TO SCALE. CHARACTERISTICS AND DIMENSIONS OF FINISHED PRODUCT MAY VARY.

- NOTES:
 1.) ROLL CAGE 5 1/2" FROM INSIDE OF REAR GUTTER. CRASH RAIL 66" FROM FLOOR.
 2.) ALL 9x7 LIGHTS TO BE WHELEN 900 SERIES LIGHTS.

3					
2					
1	PRODUCTION DRAFT	SAH			
Rev. #	Revision Description	Date	Rev'd	App'vd	
Stock/Job#:		Drawing# :	Cust. App'v/Date :	Deel. App'v/Date :	
Dealer:		23-2-TRAVOIS-100			
End Customer:		TWINRIDGE ROAD			
Drawn By:		S.A.H.	Date:	11-15-21	Scale: NOT TO SCALE
Drawing Description:		EXTERIOR LAYOUT TYPE-II MID-ROOF TRANSIT			
Revision# :		1			

NOTICE

This drawing and/or the information hereon is the exclusive property of Osage Industries and shall not be reproduced, used or disclosed without the authorized written consent of Osage Industries.

Osage Industries, Inc.
 P.O. BOX 718
 LINN, MO. 65051

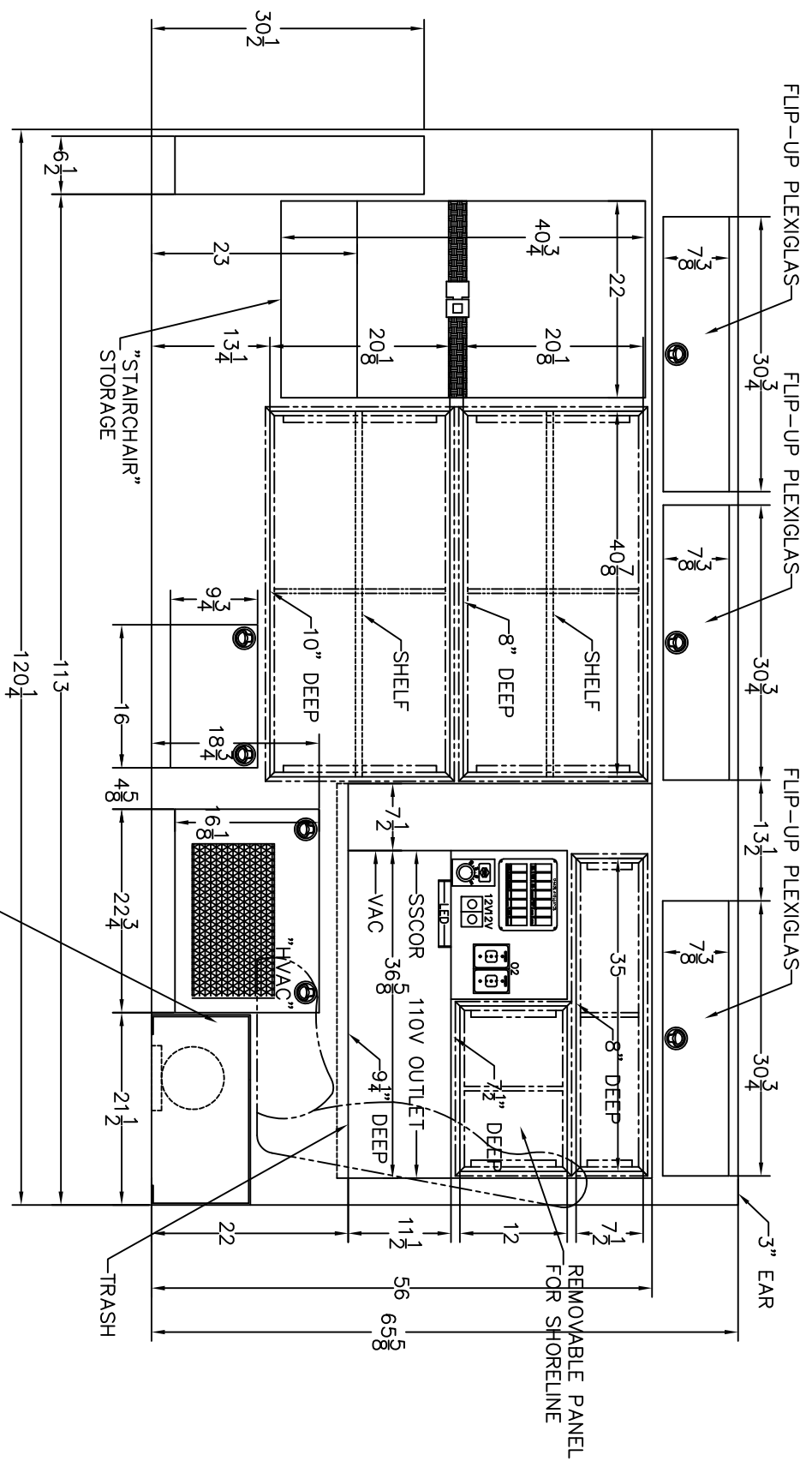

NOTES: THIS DRAWING IS NOT TO SCALE. CHARACTERISTICS AND DIMENSIONS OF FINISHED PRODUCT MAY VARY.
 NOTES: CABINET DEPTHS REPRESENT DIMENSION FROM INSIDE REAR TO FRONT FACE OF CABINETS, WITHOUT TRIM. ACTUAL WORKING DEPTH WILL BE LESS THAN DIMENSION SHOWN UNLESS OTHERWISE SPECIFIED.

3					
2					
1	PRODUCTION DRAFT	SAH			
Rev. #	Revision Description	Date	Rev'd	App'vd	

Stock/Job#:	Drawing#:	Cust. App'v/Date:	Deal. App'v/Date:
Dealer:	23-2-TRAVOIS-101		
End Customer:			

NOTICE	
Drawn By:	S.A.H.
Date:	11-15-21
Scale:	NOT TO SCALE

This drawing and/or the information hereon is the exclusive property of Osage Industries and shall not be reproduced, used or disclosed without the authorized written consent of Osage Industries.	
Drawing Description:	STREETSIDE INTERIOR TYPE-II TRANSIT
Revision#:	1

OSAGE INDUSTRIES, INC.
 TWIN RIDGE ROAD
 P.O. BOX 718
 LINN, MO. 65051

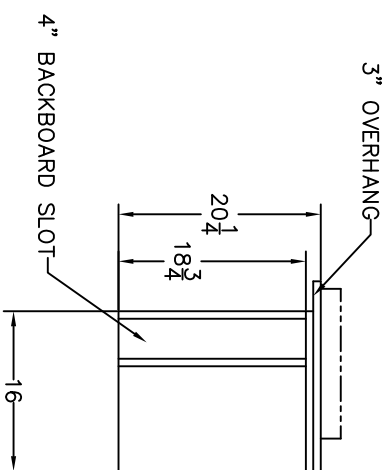
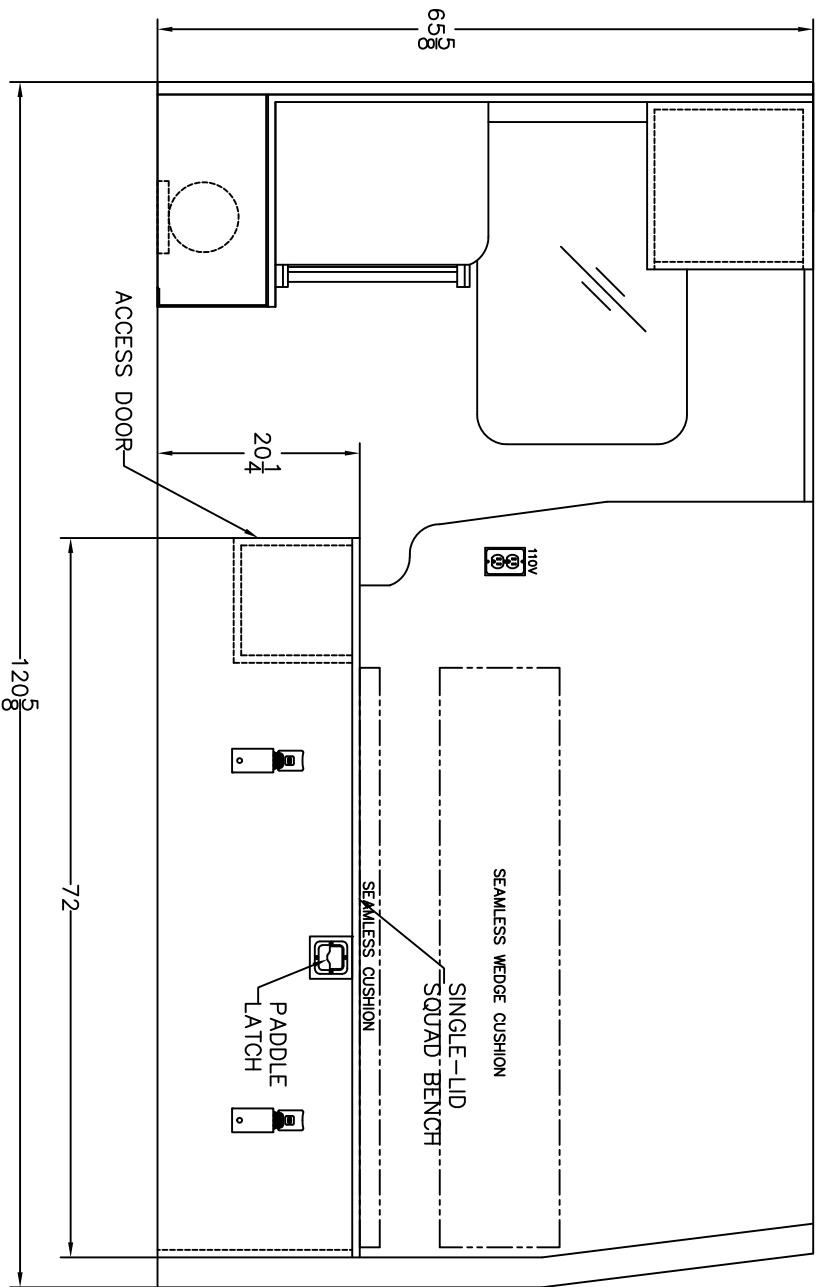

NOTES: THIS DRAWING IS NOT TO SCALE.
 CHARACTERISTICS AND DIMENSIONS OF FINISHED PRODUCT MAY VARY.

3				
2				
1	PRODUCTION DRAFT		SAH	
Rev. #	Revision Description	Date	Rev'd	App'vd

Stock/Job#:	Drawing# :	Cust. App'v/Date :	Deal. App'v/Date :
Dealer:	23-2-TRAVOIS-103		
End Customer:			
NOTICE			
This drawing and/or the information hereon is the exclusive property of Osage Industries and shall not be reproduced, used or disclosed without the authorized written consent of Osage Industries.			
Drawn By:	S.A.H.	Date:	11-15-21
Drawing Description:	CURBSIDE INTERIOR TYPE-II MID-ROOF TRANSIT		
Scale:	NOT TO SCALE		
Revision# :	1		

Osage Industries, Inc.
 TWINRIDGE ROAD P.O. BOX 718 LINN, MO. 65051

"STREETSIDE"

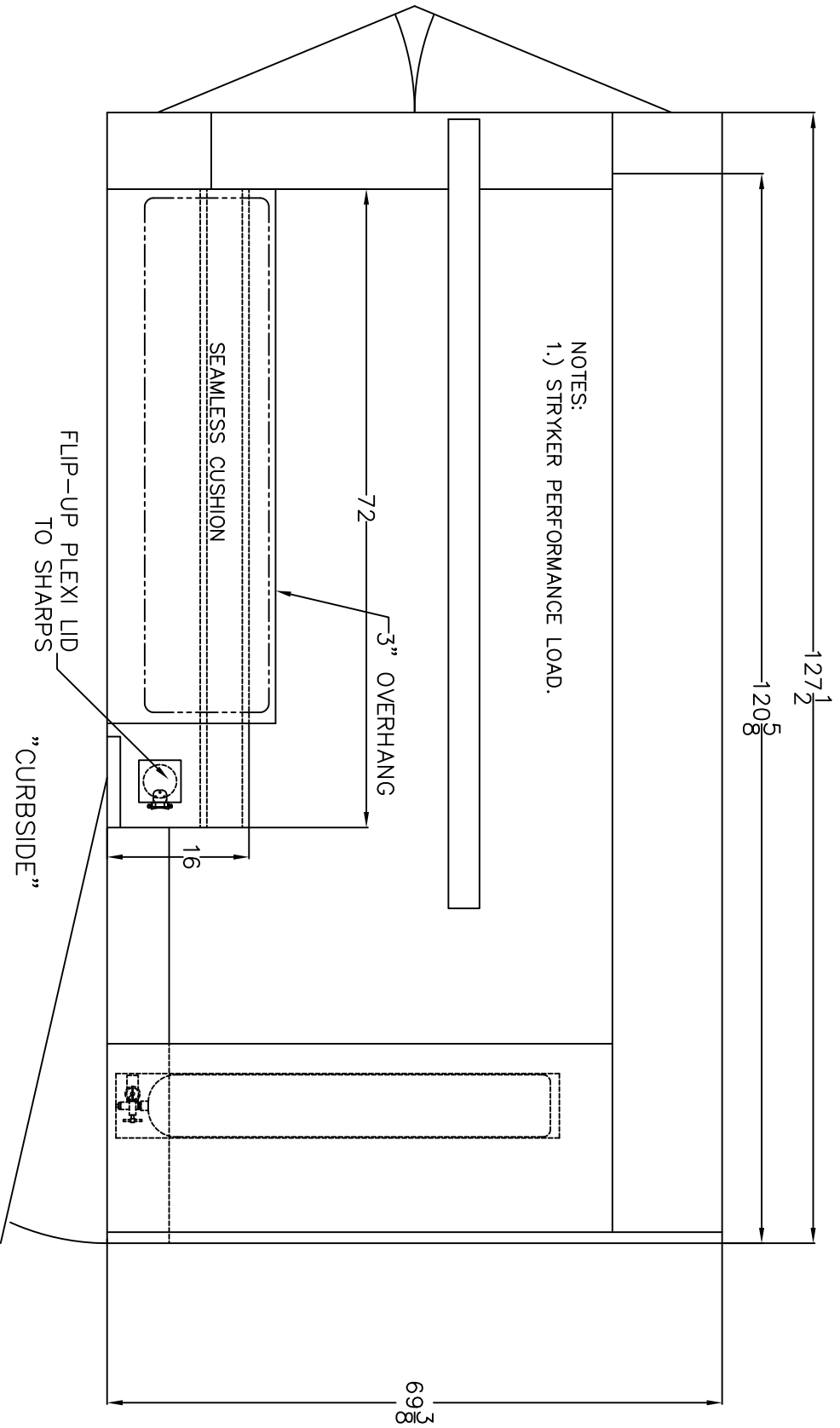

NOTES:
1.) STRYKER PERFORMANCE LOAD.

NOTES: THIS DRAWING IS NOT TO SCALE.
CHARACTERISTICS AND DIMENSIONS OF FINISHED PRODUCT MAY VARY.

Rev. #	Revision Description	Date	Rev'd	App'vd
3				
2				
1	PRODUCTION DRAFT		SAH	

Stock/Job#:	Drawing# :	Cust. App'v/Date :	Deal. App'v/Date :
Dealer:	23-2-TRAVOIS-104		
End Customer:	TWINRIDGEGE ROAD		
<p>Osage Industries, Inc. P.O. BOX 718 LINN, MO. 65051</p>			
<p>NOTICE</p> <p>This drawing and/or the information hereon is the exclusive property of Osage Industries and shall not be reproduced, used or disclosed without the authorized written consent of Osage Industries.</p>		<p>Drawing Description: FLOOR LAYOUT TYPE-II MID-ROOF TRANSIT</p>	
Drawn By:	S.A.H.	Date:	11-15-21
Scale:		NOT TO SCALE	
Revision# :			1

"STREETSIDE"

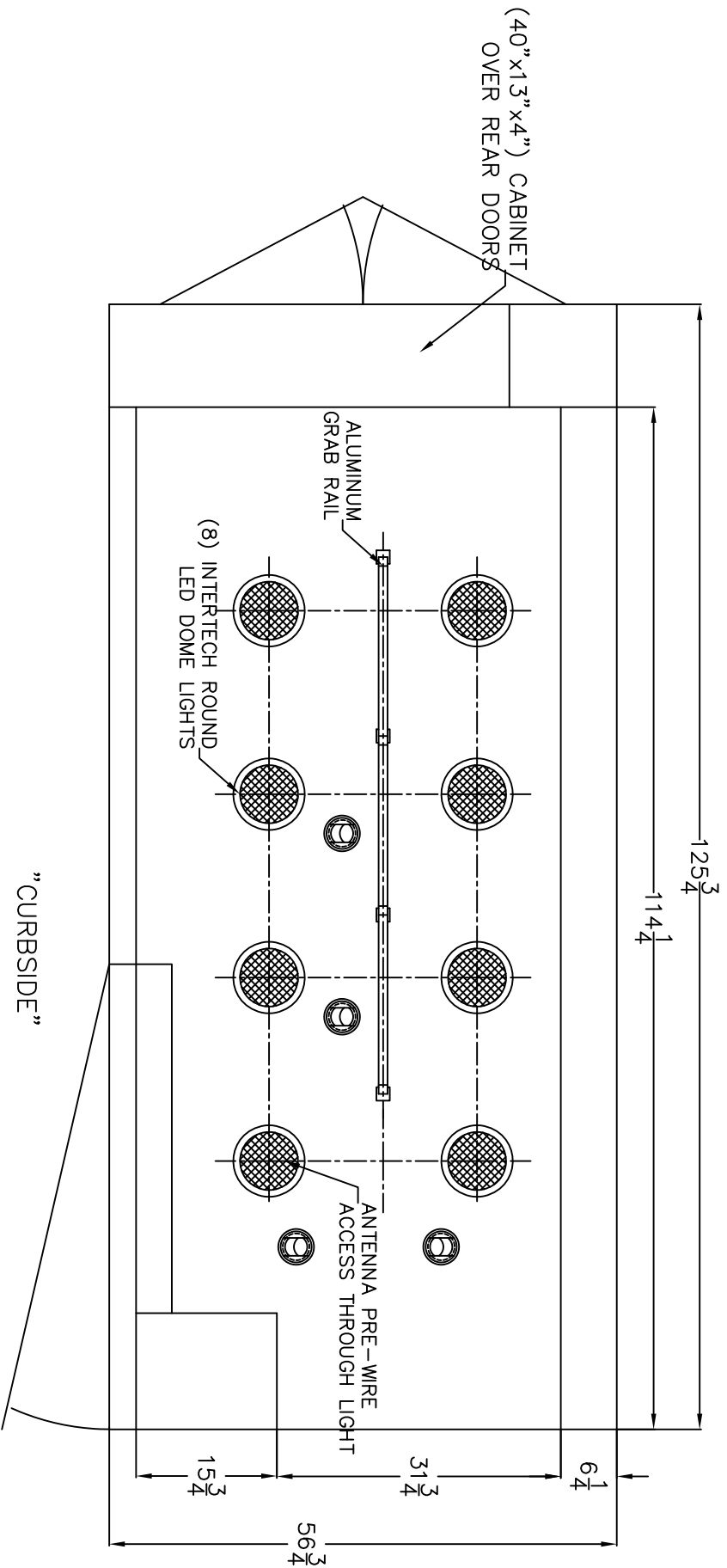

NOTES: THIS DRAWING IS NOT TO SCALE.
 CHARACTERISTICS AND DIMENSIONS OF FINISHED PRODUCT MAY VARY.

3				
2				
1	PRODUCTION DRAFT		SAH	
Rev. #	Revision Description	Date	Rev'd	App'vd

Stock/Job#:	Drawing# :	Cust. App'v/Date :	Deal. App'v/Date :
Dealer:	23-2-TRAVIS-105		
End Customer:			
NOTICE			
This drawing and/or the information hereon is the exclusive property of Osage Industries and shall not be reproduced, used or disclosed without the authorized written consent of Osage Industries.			
Drawn By:	S.A.H.	Date:	11-15-21
Scale:	NOT TO SCALE		
Drawing Description:	CEILING LAYOUT		
	TYPE-II MID-ROOF TRANSIT		
Revision# :	1		

Osage Industries, Inc.
 TWINRIDGE ROAD P.O. BOX 718 LINN, MO. 65051

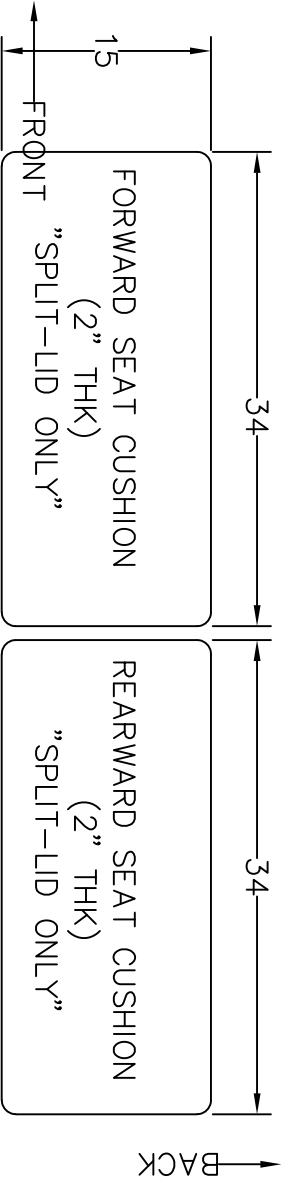
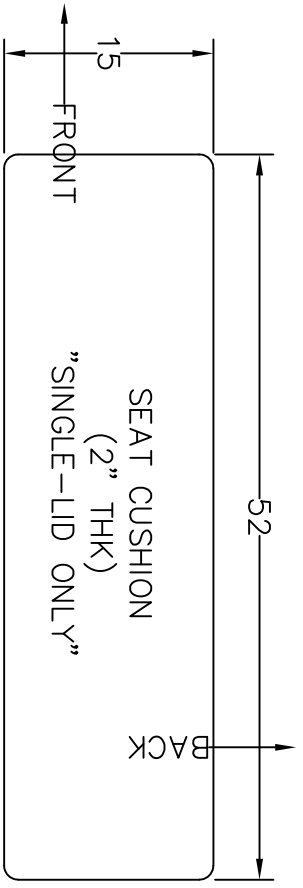
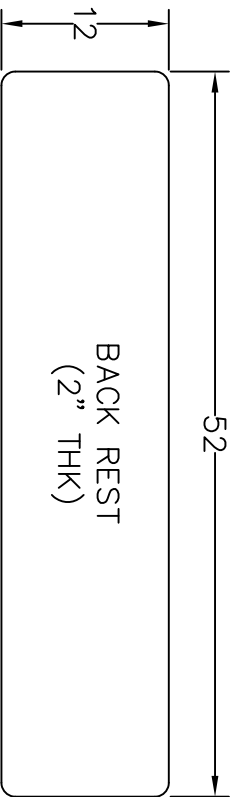

NOTES: THIS DRAWING IS NOT TO SCALE.
 CHARACTERISTICS AND DIMENSIONS OF FINISHED
 PRODUCT MAY VARY.

Stock/Job#:	Drawing#:	Cust. App'v/Date#:	Deal'r App'v/Date:
Osage Dealer:	23-2-KRAVOIS-107		
End Customer:	TWINRIDGE ROAD		
	Osage Industries, Inc.		
	P.O. BOX 718		
	LINN, MO. 63051		
NOTICE	Drawn By: S.A.H.	Date: 11-15-21	Scale: NOT TO SCALE
This drawing and/or the information hereon is the exclusive property of Osage Industries and shall not be reproduced, used or disclosed without the authorized written consent of Osage Industries.	Drawing Description:		Revision#
	E.V.S. SEAMLESS CUSHIONS		1
	SQUAD BENCH, MID-ROOF TRANSIT		
Rev.#	Revision Description	Date	Rev'd App'vd
3			
2			
1			

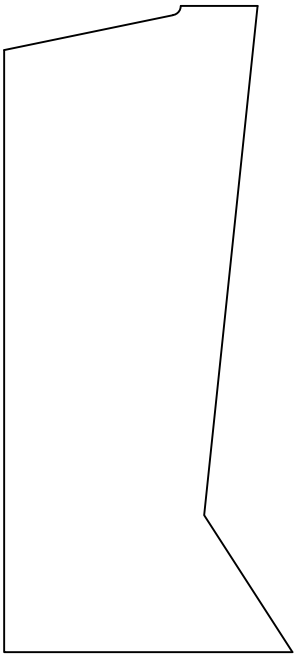
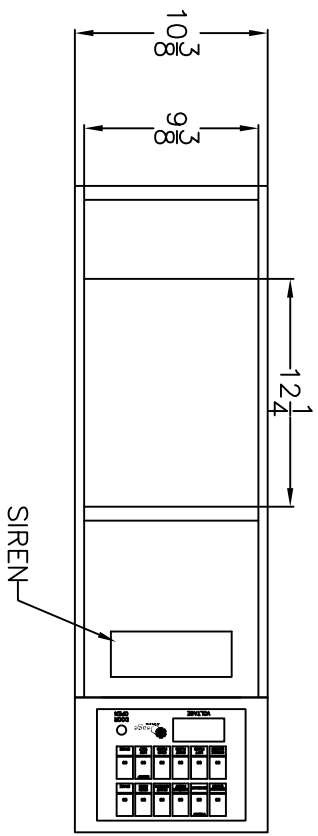

NOTES: THIS DRAWING IS NOT TO SCALE.
 CHARACTERISTICS AND DIMENSIONS OF FINISHED
 PRODUCT MAY VARY.

3			
2			
1			
Rev.#	Revision Description	Date	Rev'd App'vd

Stock/Job#:	Drawing#	Cust. App'v/Date#	Deal'r App'v/Date:
Osage Dealer:	23-2-KRAVOIS-107		
End Customer:	Osage Industries, Inc. TWINRIDGE ROAD P.O. BOX 718 LINN, MO. 65051		
NOTICE			
This drawing and/or the information hereon is the exclusive property of Osage Industries and shall not be reproduced, used or disclosed without the authorized written consent of Osage Industries.			
Drawn By:	Date:	Scale:	
S.A.H.	11-15-21	NOT TO SCALE	
Drawing Description:			Revision#
CONSOLE DRAWING, TRANSIT			1