

NOTES: THIS DRAWING IS NOT TO SCALE. CHARACTERISTICS AND DIMENSIONS OF FINISHED PRODUCT MAY VARY.

3			
2			
1	PRODUCTION DRAFT	SAH	
Rev. #	Revision Description	Date	Rev'd

Stock/Job#:	Drawing# :	Cust. App'v/Date :	Decl. App'v/Date :
Dealer:	25-2-TRAVOIS-100		
End Customer:			
NOTICE			
This drawing and/or the information hereon is the exclusive property of Osage Ambulances and shall not be reproduced, used or disclosed without the authorized written consent of Osage Ambulances.			
Drawn By:	Date:	Scale:	
S.A.H.	04-25-23	NOT TO SCALE	
Drawing Description:	EXTERIOR LAYOUT		Revision# :
TYPE-II MID-ROOF TRANSIT			1

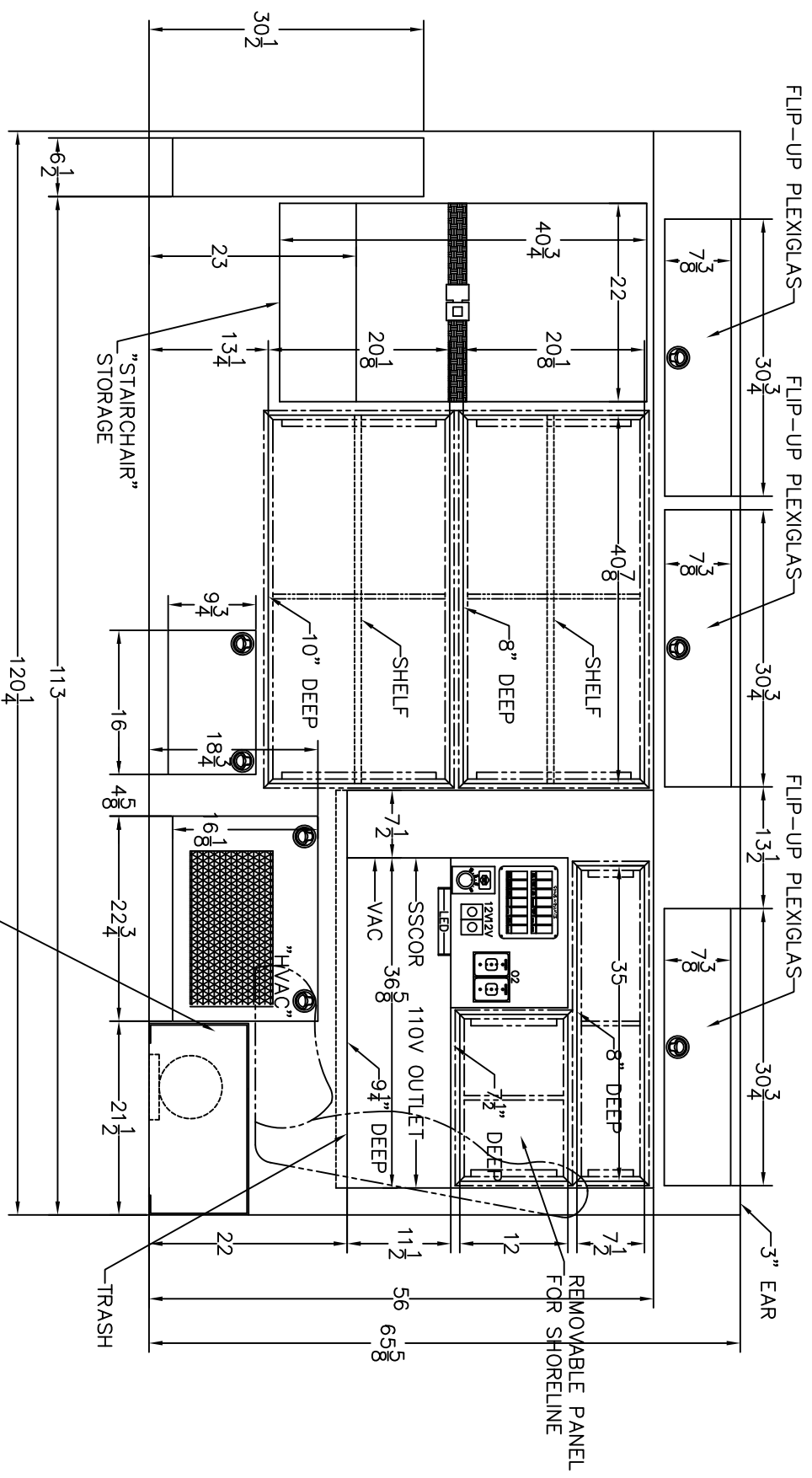

NOTES: THIS DRAWING IS NOT TO SCALE. CHARACTERISTICS AND DIMENSIONS OF FINISHED PRODUCT MAY VARY.

NOTES: CABINET DEPTHS REPRESENT DIMENSION FROM INSIDE REAR TO FRONT FACE OF CABINETS, WITHOUT TRIM. ACTUAL WORKING DEPTH WILL BE LESS THAN DIMENSION SHOWN UNLESS OTHERWISE SPECIFIED.

3					
2					
1	PRODUCTION DRAFT	SAH			
Rev. #	Revision Description	Date	Rev'd	App'vd	

Stock/Job#:	Drawing#:	Cust. App'v/Date:	Decl. App'v/Date:
Dealer:	25-2-TRAVOIS-101		
End Customer:			
Osage Ambulances			
Drawn By: S.A.H.		Date: 04-25-23	Scale: NOT TO SCALE
Drawing Description: STREETSIDE INTERIOR TYPE-II MID-ROOF TRANSIT			
			Revision #: 1

NOTICE

This drawing and/or the information herein is the exclusive property of Osage Ambulances and shall not be reproduced, used or disclosed without the authorized written consent of Osage Ambulances.

E.V.S. ATTENDANT SEAT
W/ 3-PT. HARNESS

REMOVABLE PANEL
FOR SHORELINE

TRASH

"HVAC"

"STAIRCHAIR"
STORAGE

E.V.S. ATTENDANT SEAT
W/ 3-PT. HARNESS

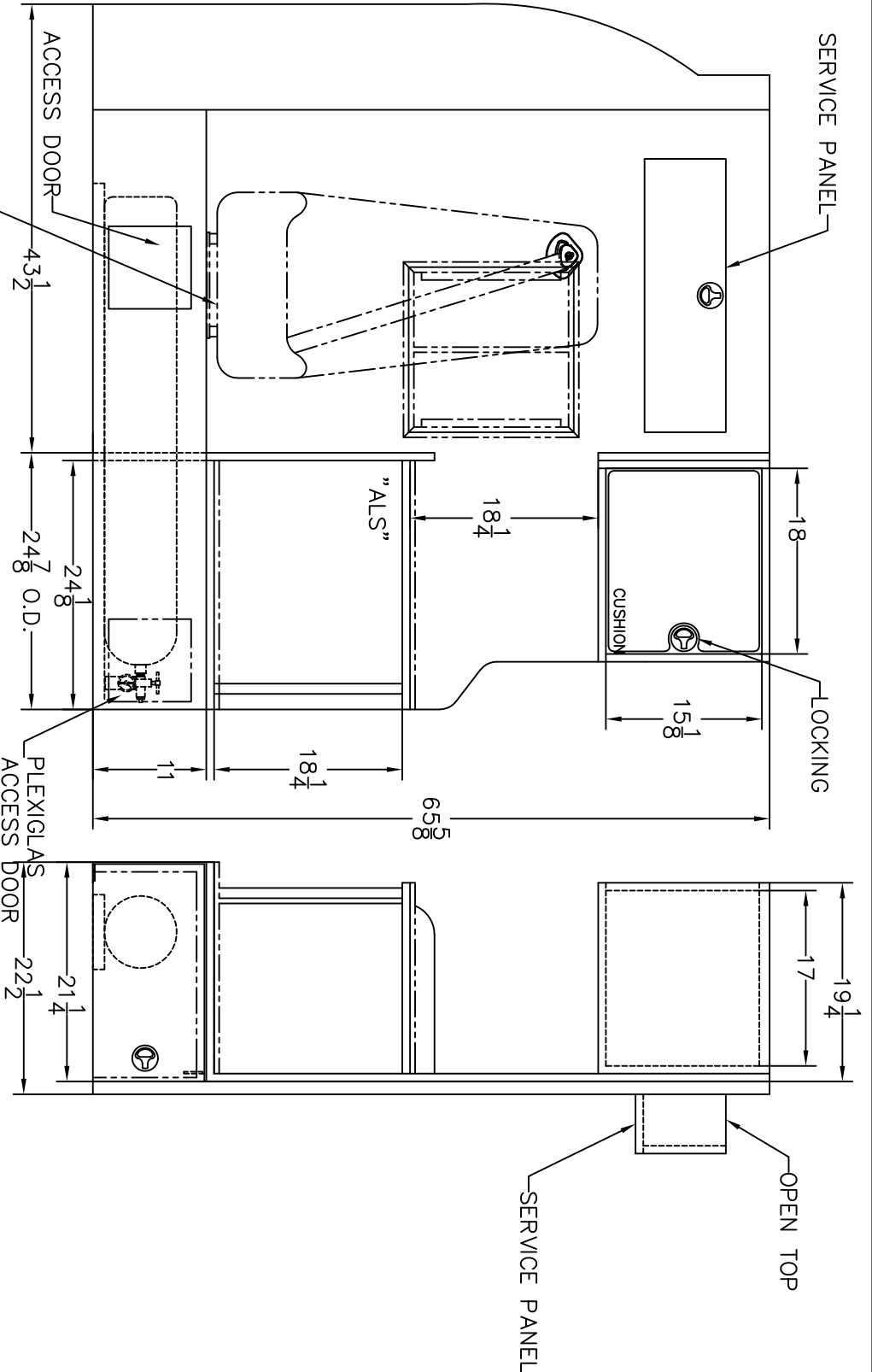

NOTES: THIS DRAWING IS NOT TO SCALE.
CHARACTERISTICS AND DIMENSIONS OF FINISHED
PRODUCT MAY VARY.

Rev. #	3			
	2			
	1	PRODUCTION DRAFT	SAH	
		Revision Description	Date	Rev'd

Stock/Job#:		Drawing# :	25-2-TRAVOIS-102	Cust. App'v/Date :		Decl. App'v/Date :	
Dealer:		Drawn By:	S.A.H.	Date:	04-25-23	Scale:	NOT TO SCALE
End Customer:		<p style="text-align: center;">Osage Ambulances</p> <p style="text-align: center;">FORWARD INTERIOR TYPE-II MID-ROOF TRANSIT</p>					
<p>This drawing and/or the information hereon is the exclusive property of Osage Ambulances and shall not be reproduced, used or disclosed without the authorized written consent of Osage Ambulances.</p>							
Rev. #	1						Revision # : 1

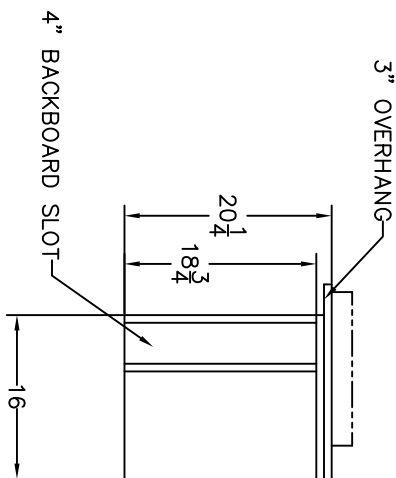
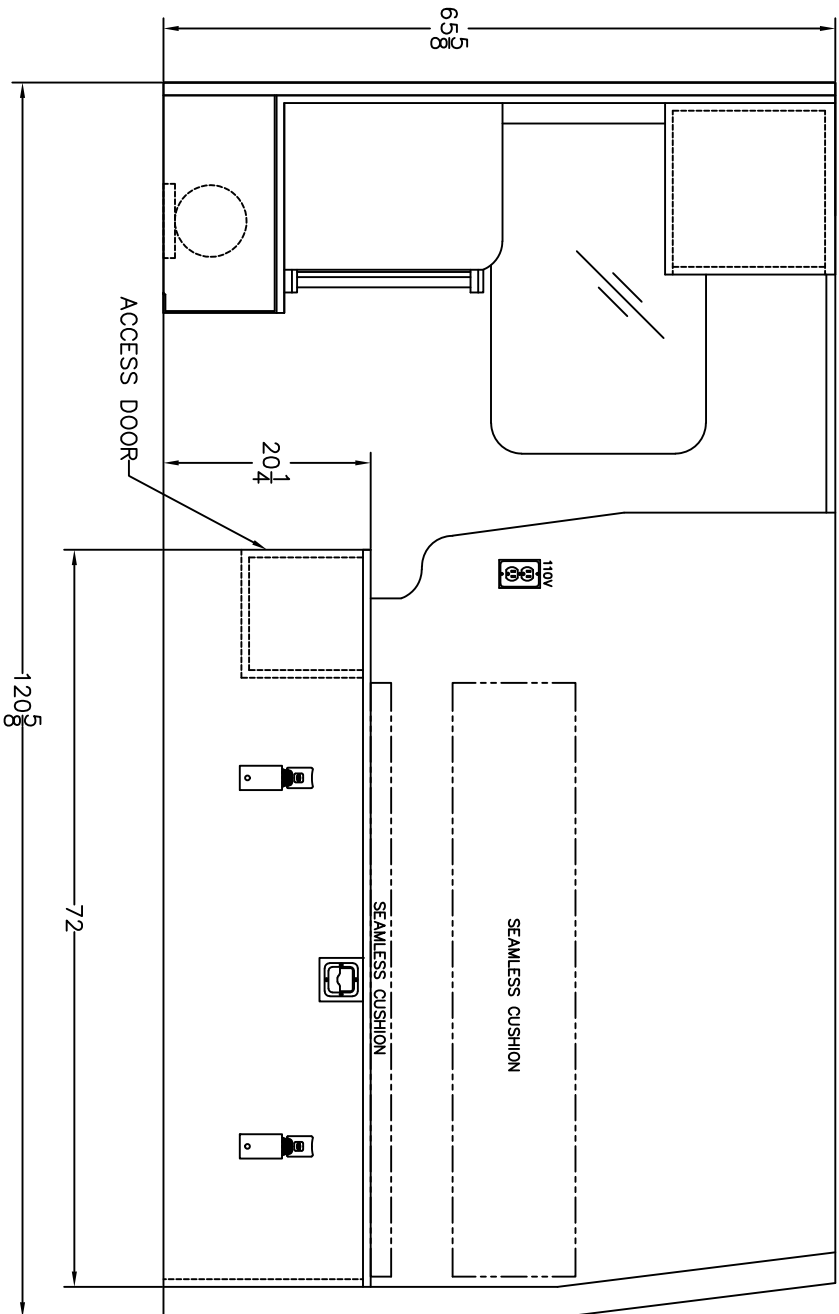

NOTES: THIS DRAWING IS NOT TO SCALE.
CHARACTERISTICS AND DIMENSIONS OF FINISHED PRODUCT MAY VARY.

Rev. #	3								
	2								
	1	PRODUCTION DRAFT		SAH					
Rev. #		Revision Description	Date	Rev'd	App'vd				

Stock/Job#:	Drawing# :	Cust. App'v/Date :	Decl. App'v/Date :
	25-2-TRAVOIS-103		
Dealer:	Osage Ambulances		
End Customer:	Osage Ambulances		

NOTICE

This drawing and/or the information hereon is the exclusive property of Osage Ambulances and shall not be reproduced, used or disclosed without the authorized written consent of Osage Ambulances.

Drawn By:	Date:	Scale:
S.A.H.	04-25-23	NOT TO SCALE
Drawing Description:	CURBSIDE INTERIOR TYPE-II MID-ROOF TRANSIT	
Revision # :	1	

"STREETSIDE"

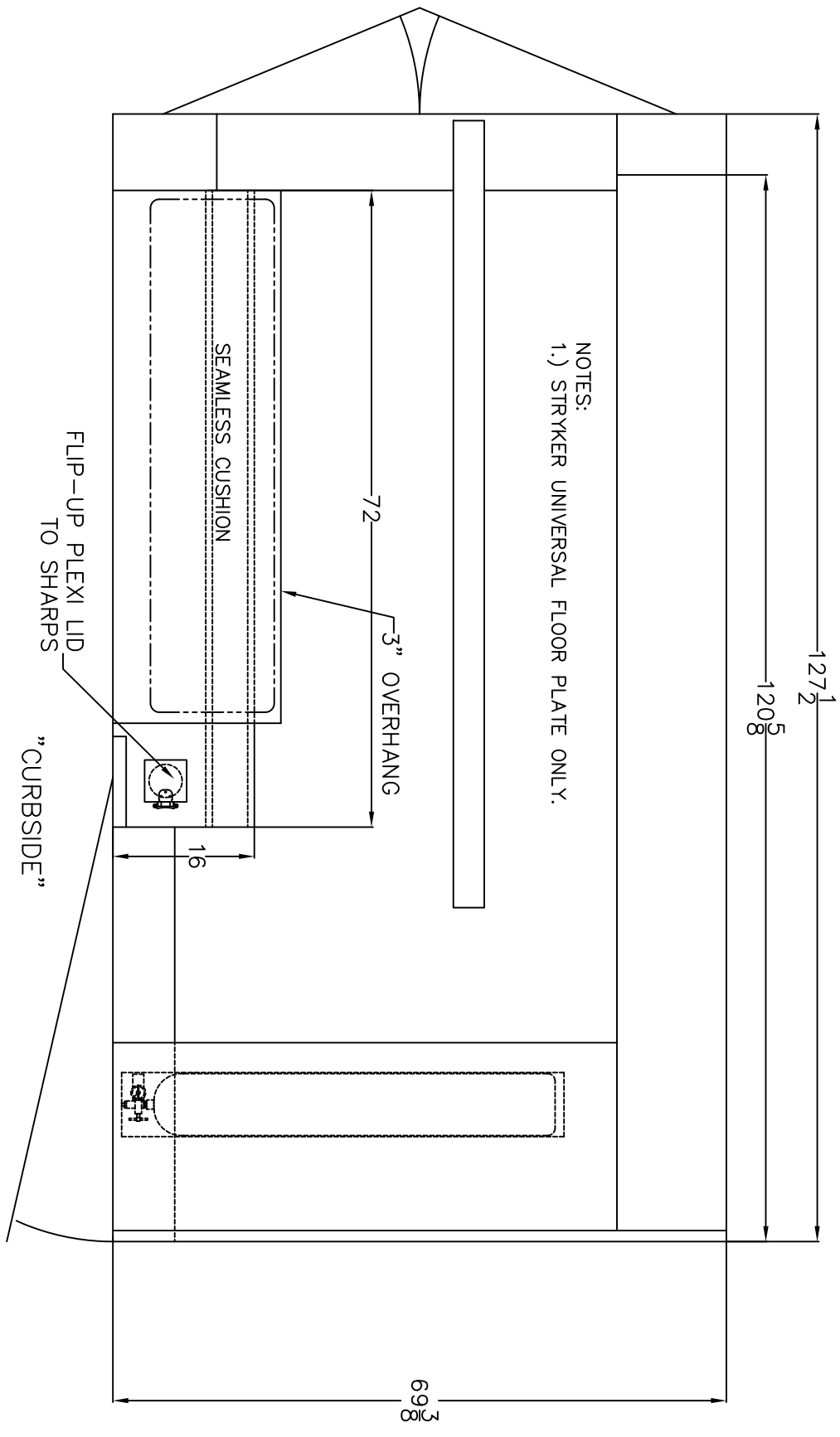

NOTES:
1.) STRYKER UNIVERSAL FLOOR PLATE ONLY.

NOTES: THIS DRAWING IS NOT TO SCALE.
CHARACTERISTICS AND DIMENSIONS OF FINISHED PRODUCT MAY VARY.

3									
2									
1		PRODUCTION DRAFT							
Rev. #		Revision Description	Date	Rev'd	App'vd				

Stock/Job#:	Drawing# :	Cust. App'v/Date :	Decl. App'v/Date :
Dealer:	25-2-TRAVOIS-104		
End Customer:			

NOTICE		Drawn By:	Date:	Scale:
This drawing and/or the information hereon is the exclusive property of Osage Ambulances and shall not be reproduced, used or disclosed without the authorized written consent of Osage Ambulances.		S.A.H.	04-25-23	NOT TO SCALE
		FLOOR LAYOUT		Revision# :
		TYPE-II MID-ROOF TRANSIT		1

“STREETSIDE”

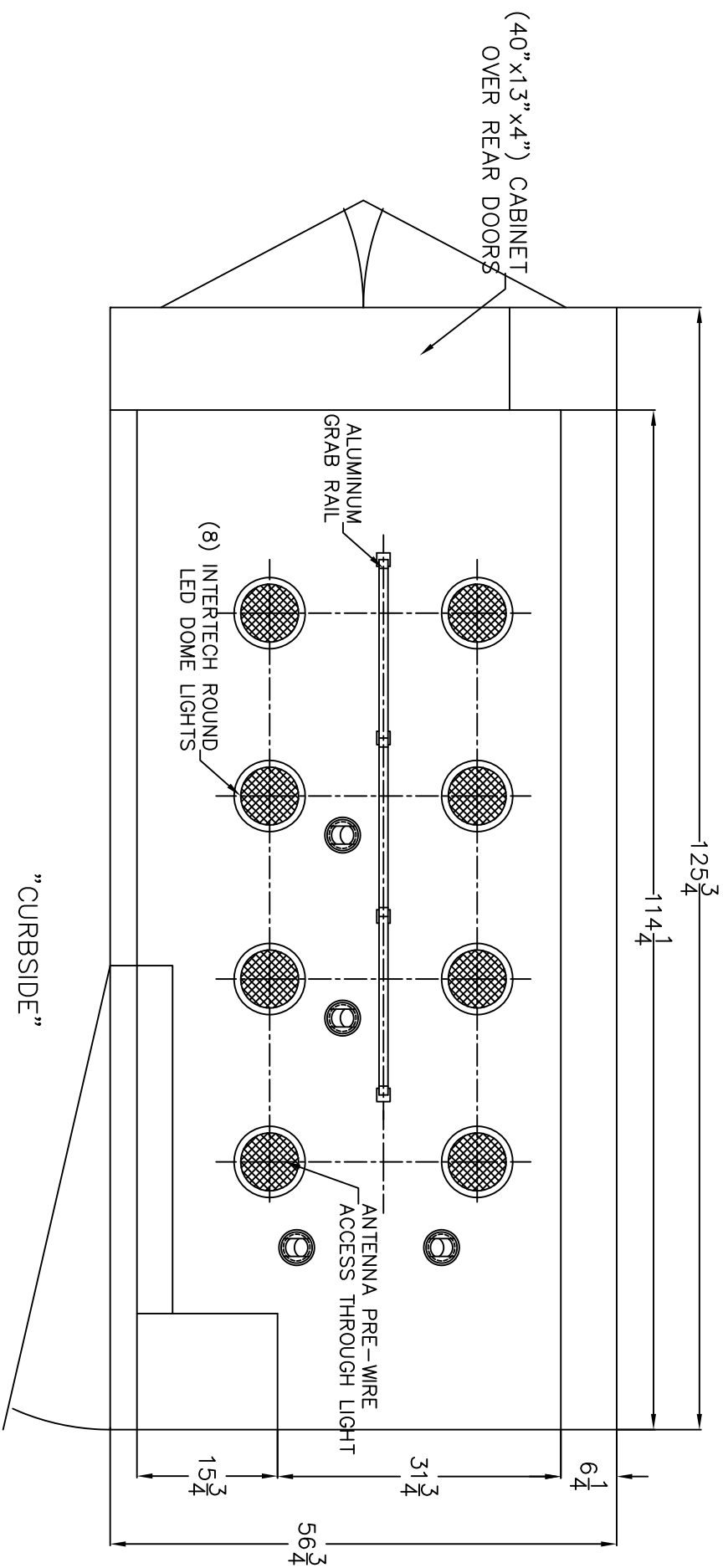

NOTES: THIS DRAWING IS NOT TO SCALE.
CHARACTERISTICS AND DIMENSIONS OF FINISHED PRODUCT MAY VARY.

3		
2		
1	PRODUCTION DRAFT	SAH
Rev. #	Revision Description	Date

Stock/Job#:	Drawing#:	Cust. App'v/Date:	Decl. App'v/Date:
End Customer:	25-2-TRAVOIS-105		
Osage Ambulances			
Drawn By:	S.A.H.	Date:	04-25-23
Drawing Description:		Scale:	NOT TO SCALE
CEILING LAYOUT		Revision #: 1	
TYPE-II MID-ROOF TRANSIT			

NOTICE

This drawing and/or the information hereon is the exclusive property of Osage Ambulances and shall not be reproduced, used or disclosed without the authorized written consent of Osage Ambulances.

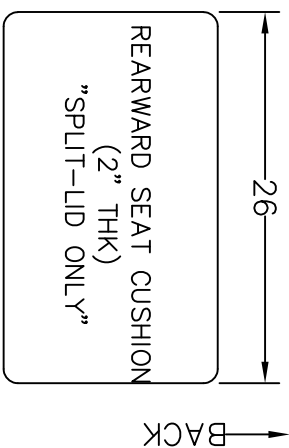
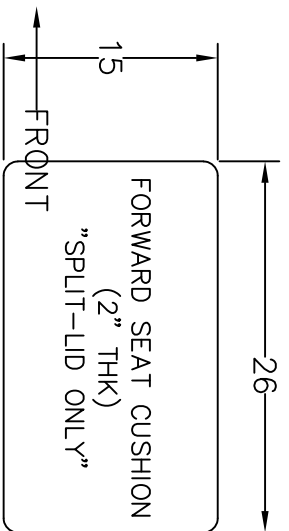
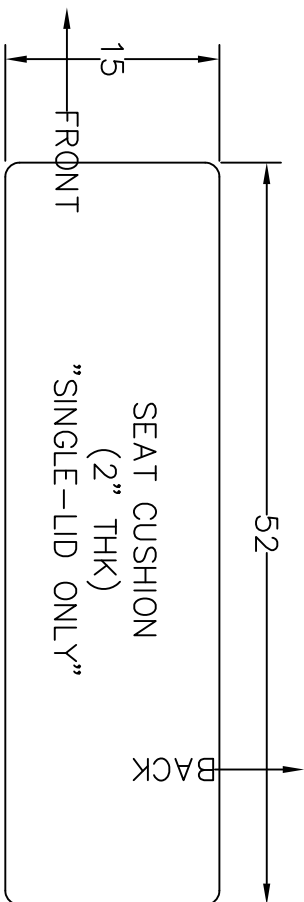
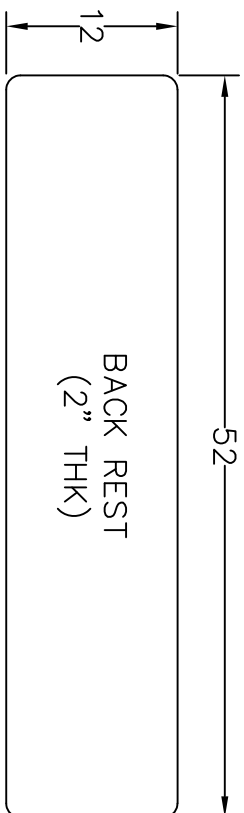

NOTES: THIS DRAWING IS NOT TO SCALE.
 CHARACTERISTICS AND DIMENSIONS OF FINISHED
 PRODUCT MAY VARY.

Rev. #	Revision Description	Date	Rev'd App'vd
3			
2			
1			

Stock/Job #:	Drawing #:	Cust. App'v/Date #	Deal'r App'v/Date:
Osage Dealer:	25-2-TRAVOIS-106		
End Customer:	<p style="text-align: center;">Osage Ambulances</p>		
NOTICE			
<p>This drawing and/or the information hereon is the exclusive property of Osage Ambulances and shall not be reproduced, used or disclosed without the authorized written consent of Osage Ambulances.</p>			
Drawn By:	Date:	Scale:	
S.A.H.	04-25-23	NOT TO SCALE	
Drawing Description:	E.V.S. SEAMLESS CUSHIONS SQUAD BENCH, MID-ROOF TRANSIT		
	Revision #		
	1		

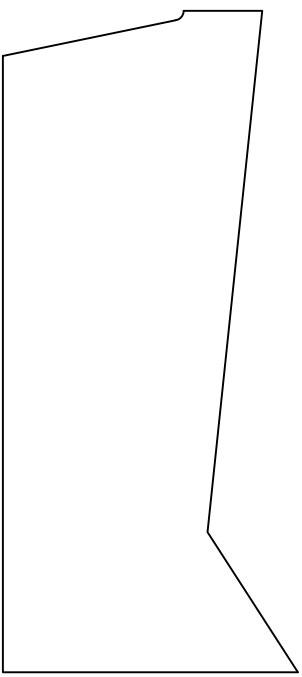
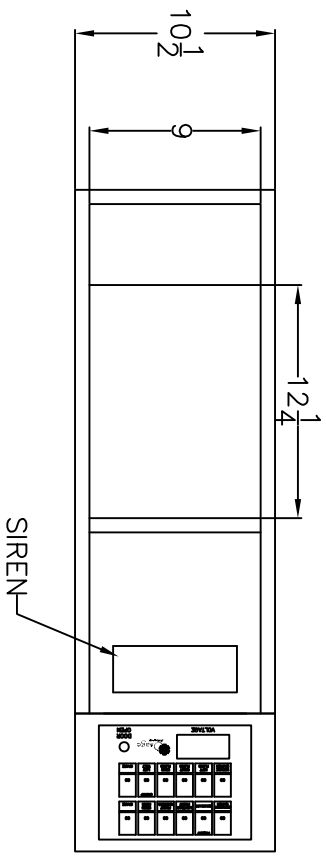

NOTES: THIS DRAWING IS NOT TO SCALE.
 CHARACTERISTICS AND DIMENSIONS OF FINISHED
 PRODUCT MAY VARY.

Rev. #	Revision Description	Date	Rev'd	App'vd
3				
2				
1				

Stock/Job #:	Drawing #:	Cust. App'v/Date #	Deal'r App'v/Date:
Osage Dealer:	25-2-TRAVOIS-107		
End Customer:	<p style="text-align: center;">Osage Ambulances</p>		
NOTICE			
<p>This drawing and/or the information hereon is the exclusive property of Osage Ambulances and shall not be reproduced, used or disclosed without the authorized written consent of Osage Ambulances.</p>		Drawn By: S.A.H.	Date: 04-25-23
<p>Drawing Description:</p> <p>CONSOLE DRAWING, MID-ROOF TRANSIT</p>		Scale: NOT TO SCALE	Revision #
			1