

NOTES: THIS DRAWING IS NOT TO SCALE. CHARACTERISTICS AND DIMENSIONS OF FINISHED PRODUCT MAY VARY.

|        |                      |      |       |        |
|--------|----------------------|------|-------|--------|
| 3      |                      |      |       |        |
| 2      |                      |      |       |        |
| 1      | PRODUCTION DRAFT     | SAH  |       |        |
| Rev. # | Revision Description | Date | Rev'd | App'vd |

|   |                  |                    |                    |
|---|------------------|--------------------|--------------------|
| Stock/Job #:  | Drawing# :       | Cust. App'v/Date : | Decl. App'v/Date : |
| Dealer:   | 25-2-TRAVOIS-100 |                    |                    |
| End Customer:   |                  |                    |                    |
| <b>NOTICE</b>   |                  |                    |                    |
| This drawing and/or the information hereon is the exclusive property of Osage Ambulances and shall not be reproduced, used or disclosed without the authorized written consent of Osage Ambulances. |                  |                    |                    |
| Drawn By:   | Date:            | Scale:             |                    |
| S.A.H.  | 04-25-23         | NOT TO SCALE       |                    |
| Drawing Description:  | EXTERIOR LAYOUT  |                    | Revision # :       |
| TYPE-II HIGH-ROOF TRANSIT   |                  |                    | 1                  |

# Osage Ambulances

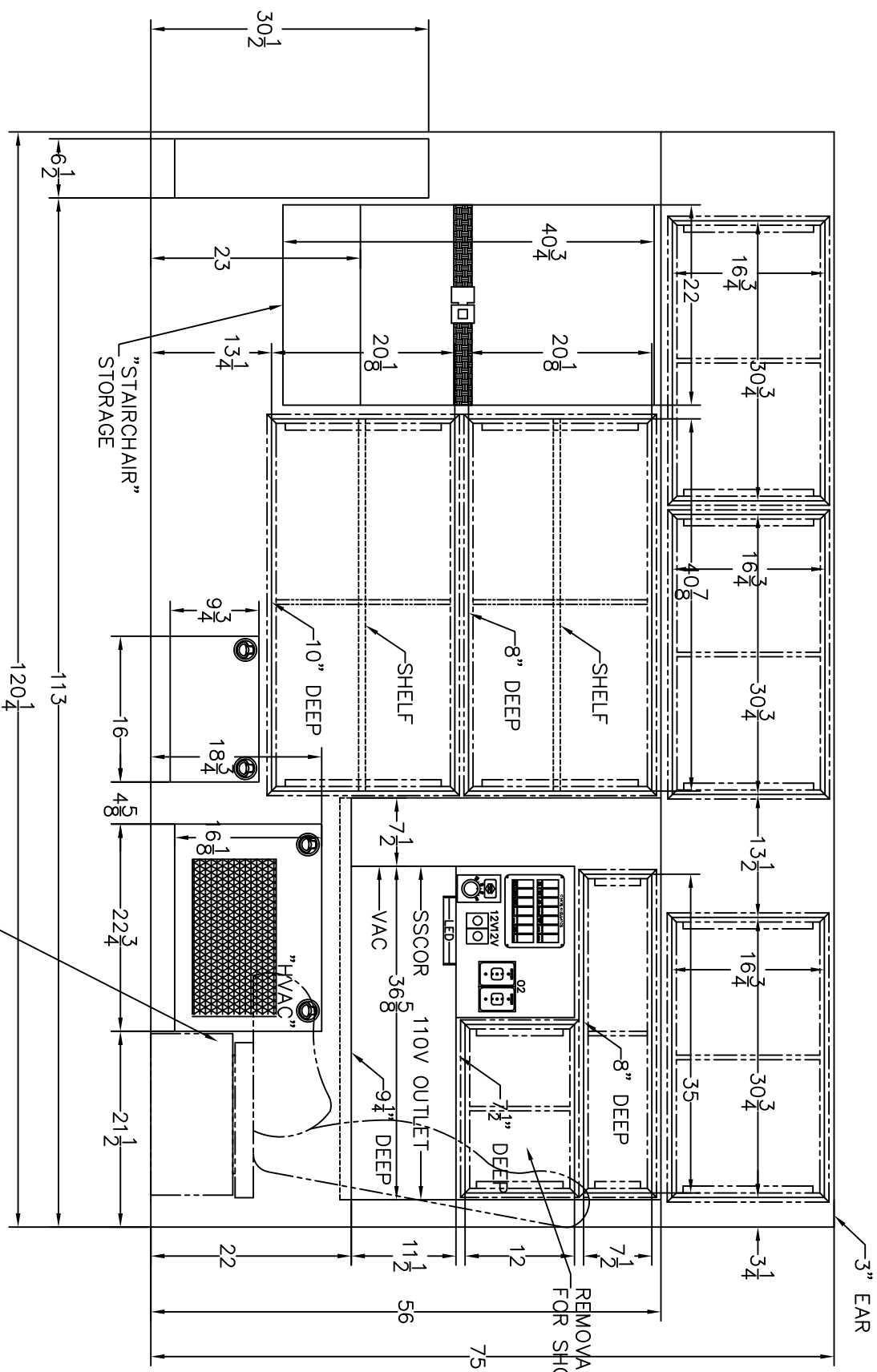

NOTES: THIS DRAWING IS NOT TO SCALE. CHARACTERISTICS AND DIMENSIONS OF FINISHED PRODUCT MAY VARY.

NOTES: CABINET DEPTHS REPRESENT DIMENSION FROM INSIDE REAR TO FRONT FACE OF CABINETS, WITHOUT TRIM. ACTUAL WORKING DEPTH WILL BE LESS THAN DIMENSION SHOWN UNLESS OTHERWISE SPECIFIED.

E.V.S. ATTENDANT SEAT  
W/ 3-PT. HARNESS

|        |                      |      |       |        |
|--------|----------------------|------|-------|--------|
| 3      |                      |      |       |        |
| 2      |                      |      |       |        |
| 1      | PRODUCTION DRAFT     |      | SAH   |        |
| Rev. # | Revision Description | Date | Rev'd | App'vd |

|   |   |                   |                   |
|---|---|-------------------|-------------------|
| Stock/Job#:   | Drawing#:                                     | Cust. App'v/Date: | Decl. App'v/Date: |
| Dealer:   | 25-2-TRAVOIS-101                              |                   |                   |
| End Customer:   |   |                   |                   |
| <b>NOTICE</b>   |   |                   |                   |
| This drawing and/or the information herein is the exclusive property of Osage Ambulances and shall not be reproduced, used or disclosed without the authorized written consent of Osage Ambulances. |   |                   |                   |
| Drawn By:   | S.A.H.  | Date:             | 04-25-23          |
| Drawing Description:  | STREETSIDE INTERIOR TYPE-II HIGH-ROOF TRANSIT |                   |                   |
| Scale:  | NOT TO SCALE                                  |                   |                   |
| Revision #:   | 1   |                   |                   |

**Osage Ambulances**

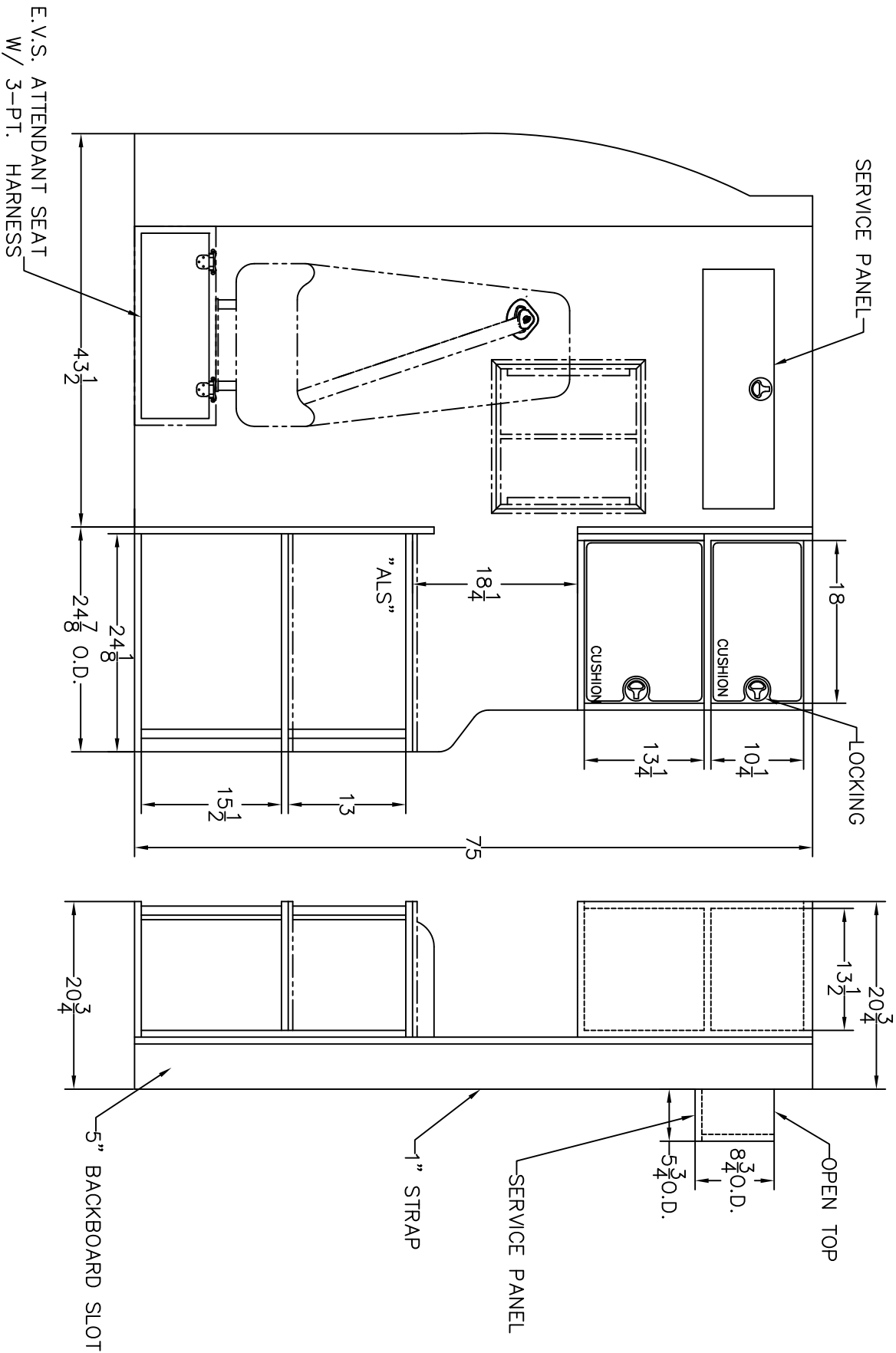

NOTES: THIS DRAWING IS NOT TO SCALE.  
 CHARACTERISTICS AND DIMENSIONS OF FINISHED  
 PRODUCT MAY VARY.

|        |                      |      |       |        |  |  |  |  |  |  |
|--------|----------------------|------|-------|--------|--|--|--|--|--|--|
| 3      |                      |      |       |        |  |  |  |  |  |  |
| 2      |                      |      |       |        |  |  |  |  |  |  |
| 1      | PRODUCTION DRAFT     |      | SAH   |        |  |  |  |  |  |  |
| Rev. # | Revision Description | Date | Rev'd | App'vd |  |  |  |  |  |  |

|               |                  |                   |                   |
|---------------|------------------|-------------------|-------------------|
| Stock/Job#:   | Drawing#:        | Cust. App'v/Date: | Devl. App'v/Date: |
| Dealer:       | 25-2-TRAVOIS-102 |                   |                   |
| End Customer: |                  |                   |                   |

**Osage Ambulances**

|           |          |              |
|-----------|----------|--------------|
| Drawn By: | Date:    | Scale:       |
| S.A.H.    | 04-25-23 | NOT TO SCALE |

NOTICE  
 This drawing and/or the information hereon is the exclusive property of Osage Ambulances and shall not be reproduced, used or disclosed without the authorized written consent of Osage Ambulances.

FORWARD INTERIOR  
 TYPE-II HIGH-ROOF TRANSIT

|            |   |
|------------|---|
| Revision#: | 1 |
|------------|---|

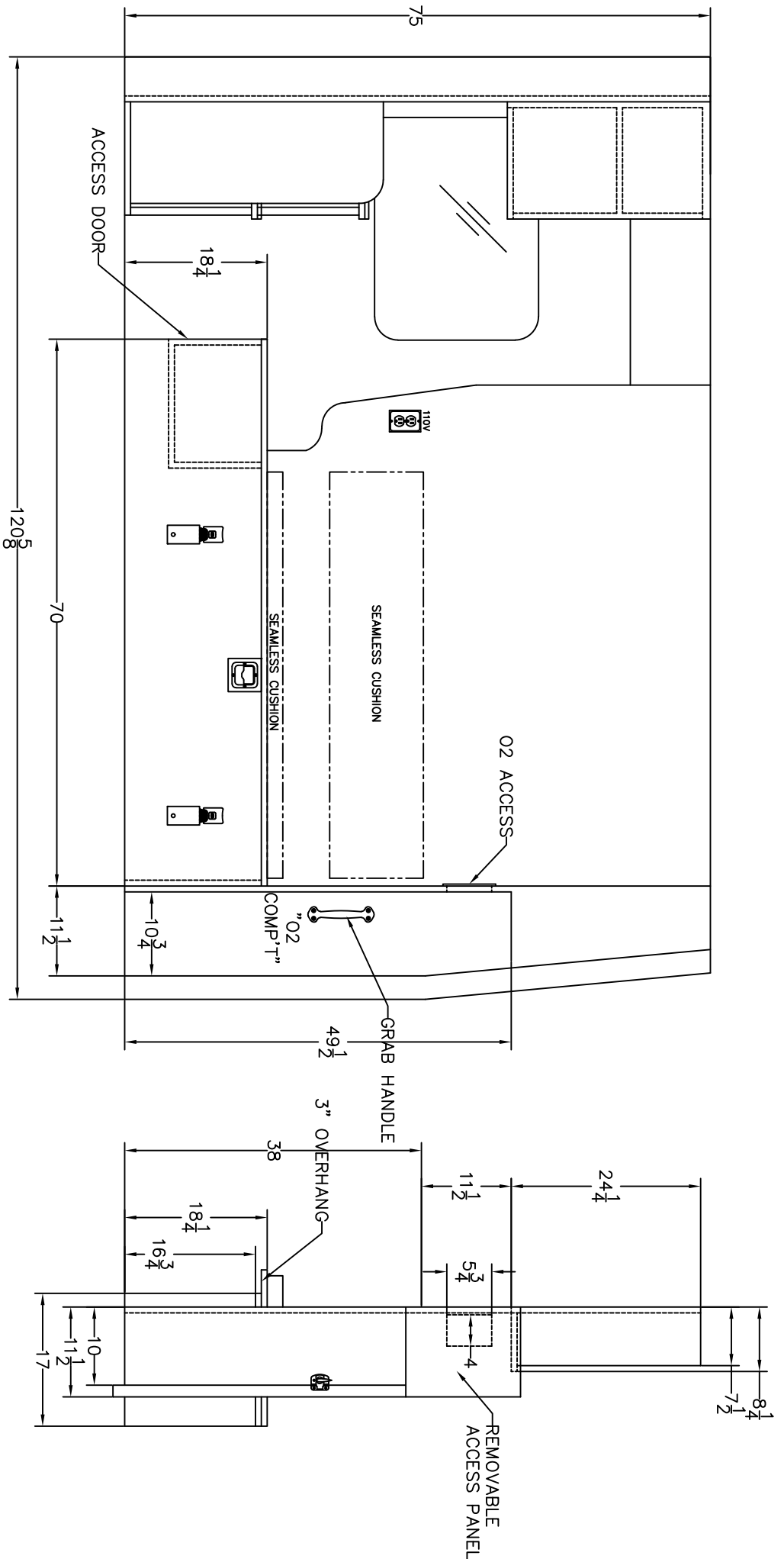

NOTES: THIS DRAWING IS NOT TO SCALE.  
 CHARACTERISTICS AND DIMENSIONS OF FINISHED PRODUCT MAY VARY.

|               |                  |                    |                    |
|---------------|------------------|--------------------|--------------------|
| Stock/Job#:   | Drawing# :       | Cust. App'v/Date : | Decl. App'v/Date : |
| Dealer:       | 25-2-TRAVOIS-103 |                    |                    |
| End Customer: |                  |                    |                    |

**NOTICE**

This drawing and/or the information hereon is the exclusive property of Osage Ambulances and shall not be reproduced, used or disclosed without the authorized written consent of Osage Ambulances.

# Osage Ambulances

|           |          |              |
|-----------|----------|--------------|
| Drawn By: | Date:    | Scale:       |
| S.A.H.    | 04-25-23 | NOT TO SCALE |

CURBSIDE INTERIOR  
 TYPE-II HIGH-ROOF TRANSIT

Revision# :

1

|        |                      |      |       |        |
|--------|----------------------|------|-------|--------|
| Rev. # | Revision Description | Date | Rev'd | App'vd |
| 3      |                      |      |       |        |
| 2      | PRODUCTION DRAFT     |      | SAH   |        |
| 1      | Revision Description |      |       |        |

"STREETSIDE"

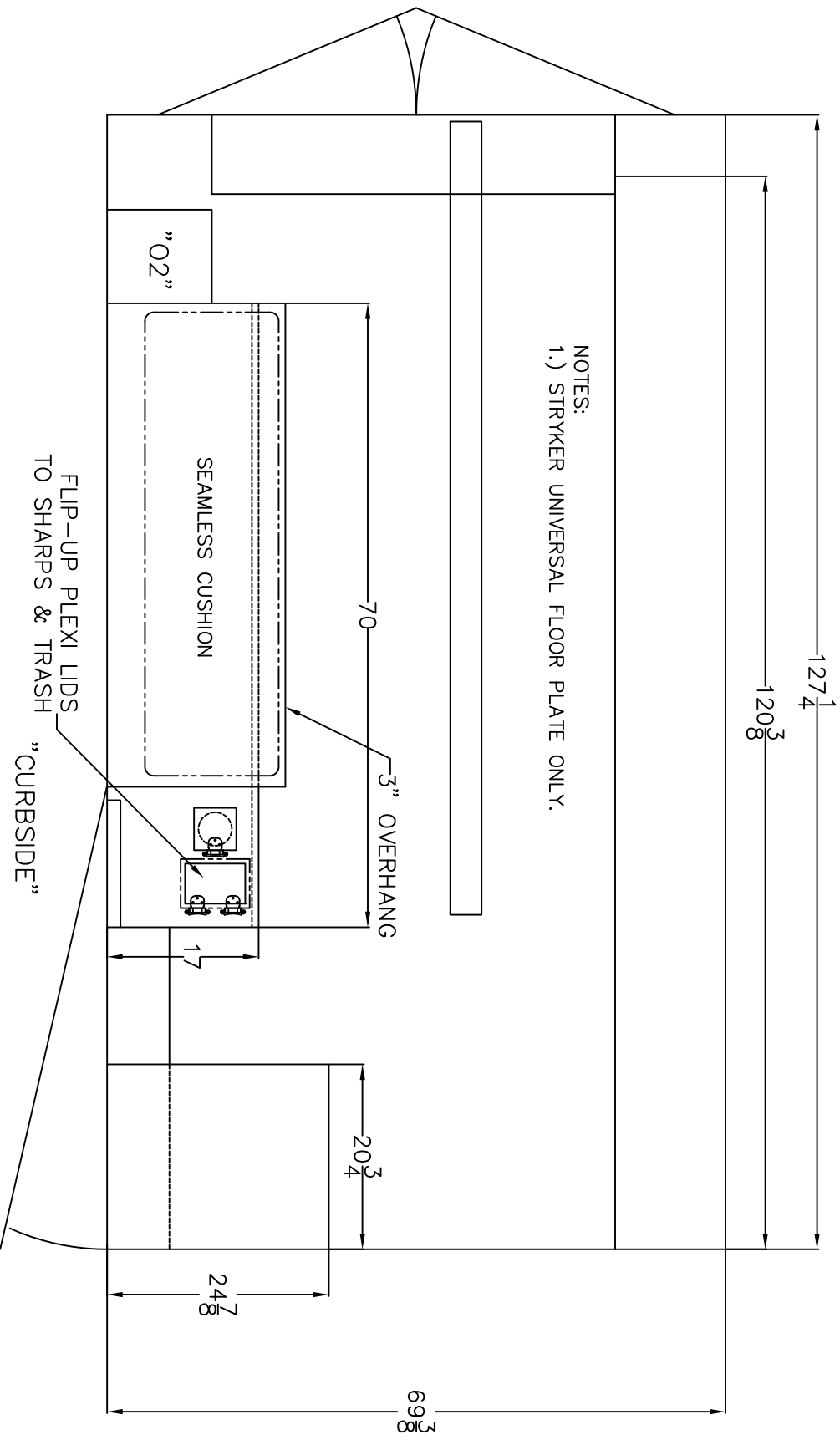

NOTES:  
1.) STRYKER UNIVERSAL FLOOR PLATE ONLY.

NOTES: THIS DRAWING IS NOT TO SCALE.  
CHARACTERISTICS AND DIMENSIONS OF FINISHED PRODUCT MAY VARY.

|        |  |                      |      |       |        |  |  |  |  |
|--------|--|----------------------|------|-------|--------|--|--|--|--|
| 3      |  |                      |      |       |        |  |  |  |  |
| 2      |  |                      |      |       |        |  |  |  |  |
| 1      |  | PRODUCTION DRAFT     |      |       |        |  |  |  |  |
| Rev. # |  | Revision Description | Date | Rev'd | App'vd |  |  |  |  |

  

|               |                  |                    |                    |
|---------------|------------------|--------------------|--------------------|
| Stock/Job#:   | Drawing# :       | Cust. App'v/Date : | Decl. App'v/Date : |
| Dealer:       | 25-2-TRAVOIS-104 |                    |                    |
| End Customer: |                  |                    |                    |

|   |  |   |          |                  |
|---|--|---|----------|------------------|
| NOTICE  |  | Drawn By:                                 | Date:    | Scale:           |
| This drawing and/or the information hereon is the exclusive property of Osage Ambulances and shall not be reproduced, used or disclosed without the authorized written consent of Osage Ambulances. |  | S.A.H.                                    | 04-25-23 | NOT TO SCALE     |
|   |  | FLOOR LAYOUT<br>TYPE-II HIGH-ROOF TRANSIT |          | Revision# :<br>1 |

"STREETSIDE"

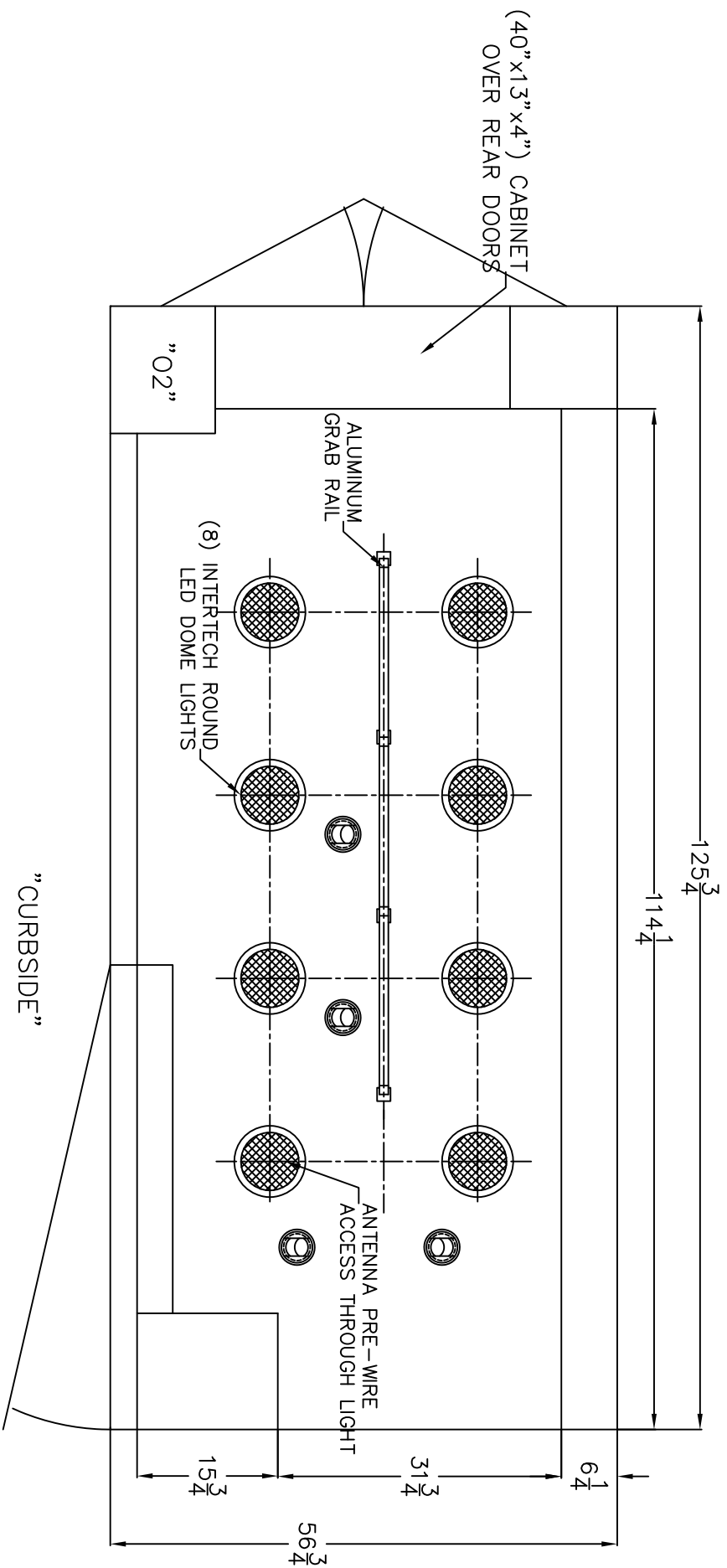

NOTES: THIS DRAWING IS NOT TO SCALE.  
CHARACTERISTICS AND DIMENSIONS OF FINISHED PRODUCT MAY VARY.

|               |  |                      |      |                   |        |   |  |  |  |
|---------------|--|----------------------|------|-------------------|--------|---|--|--|--|
| 3             |  |                      |      |                   |        |   |  |  |  |
| 2             |  |                      |      |                   |        |   |  |  |  |
| 1             |  | PRODUCTION DRAFT     |      | SAH               |        |   |  |  |  |
| Rev. #        |  | Revision Description | Date | Rev'd             | App'vd | This drawing and/or the information hereon is the exclusive property of Osage Ambulances and shall not be reproduced, used or disclosed without the authorized written consent of Osage Ambulances. |  |  |  |
| Stock/Job#:   |  | Drawing#:            |      | Cust. App'v/Date: |        | Decl. App'v/Date:   |  |  |  |
| Dealer:       |  | 25-2-TRAVOIS-105     |      |                   |        |   |  |  |  |
| End Customer: |  |                      |      |                   |        |   |  |  |  |
| NOTICE        |  |                      |      |                   |        | Drawn By: S.A.H. Date: 04-25-23 Scale: NOT TO SCALE   |  |  |  |
|               |  |                      |      |                   |        | Drawing Description: CEILING LAYOUT TYPE-II HIGH-ROOF TRANSIT   |  |  |  |
|               |  |                      |      |                   |        | Revision #: 1   |  |  |  |

Osage Ambulances

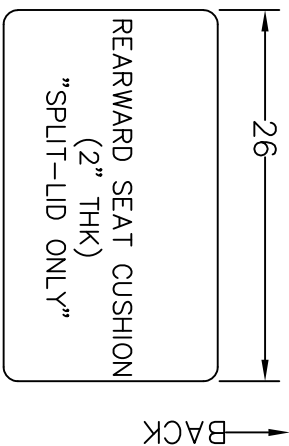
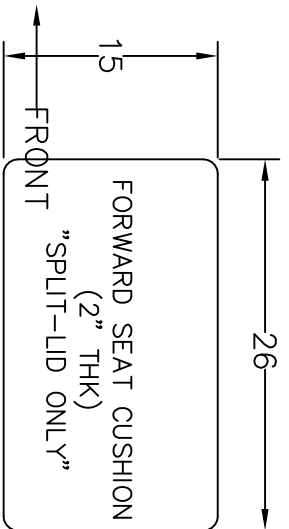
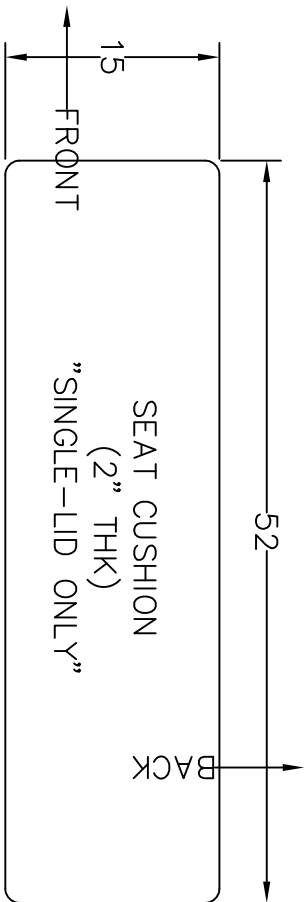
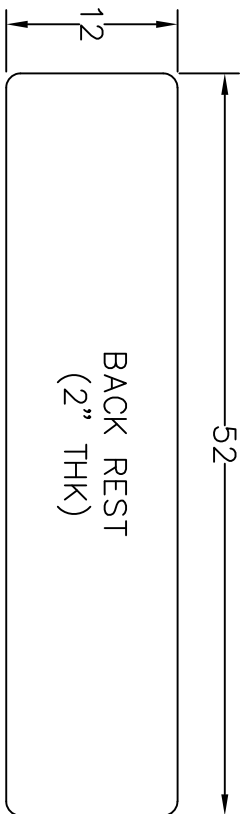

NOTES: THIS DRAWING IS NOT TO SCALE.  
 CHARACTERISTICS AND DIMENSIONS OF FINISHED  
 PRODUCT MAY VARY.

|               |                         |                   |                    |
|---------------|-------------------------|-------------------|--------------------|
| Stock/Job#:   | Drawing#                | Cust. App'v/Date# | Deal'r App'v/Date: |
| Osage Dealer: | 25-2-TRAVOIS-106        |                   |                    |
| End Customer: | <b>Osage Ambulances</b> |                   |                    |

|   |  |                      |  |       |          |        |              |
|---|--|----------------------|--|-------|----------|--------|--------------|
| NOTICE  |  | Drawn By:            | S.A.H.   | Date: | 04-25-23 | Scale: | NOT TO SCALE |
| This drawing and/or the information hereon is the exclusive property of Osage Ambulances and shall not be reproduced, used or disclosed without the authorized written consent of Osage Ambulances. |  | Drawing Description: | E.V.S. SEAMLESS CUSHIONS<br>SQUAD BENCH, HIGH-ROOF TRANSIT |       |          |        |              |

| Rev. # | Revision Description | Date | Rev'd App'vd |
|--------|----------------------|------|--------------|
| 3      |                      |      |              |
| 2      |                      |      |              |
| 1      |                      |      |              |

|           |   |
|-----------|---|
| Revision# | 1 |
|-----------|---|

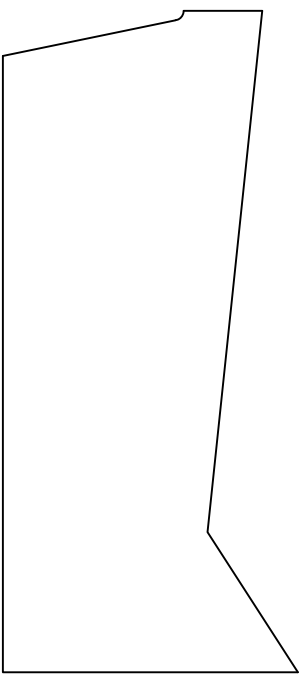
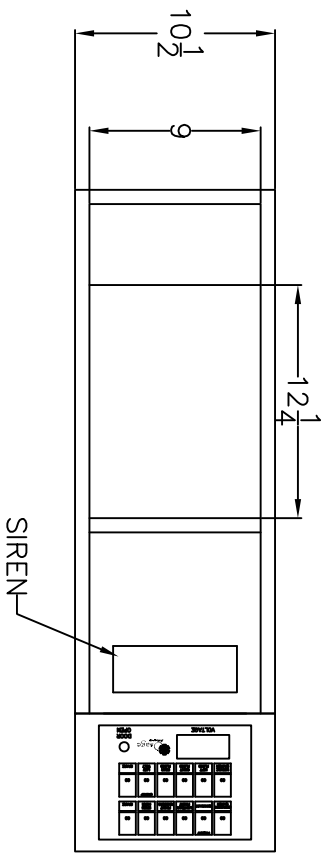

NOTES: THIS DRAWING IS NOT TO SCALE.  
 CHARACTERISTICS AND DIMENSIONS OF FINISHED  
 PRODUCT MAY VARY.

| 3      |                      |      |              |
|--------|----------------------|------|--------------|
| 2      |                      |      |              |
| 1      |                      |      |              |
| Rev. # | Revision Description | Date | Rev'd App'vd |

|  |  |                   |                    |
|--|--|-------------------|--------------------|
| Stock/Job#:  | Drawing#:  | Cust. App'v/Date# | Deal'r App'v/Date: |
| Osage Dealer:  | 25-2-TRAVOIS-107   |                   |                    |
| End Customer:  | <p style="text-align: center;"><b>Osage Ambulances</b></p> |                   |                    |
| NOTICE   |  |                   |                    |
| <p>This drawing and/or the information hereon is the exclusive property of Osage Ambulances and shall not be reproduced, used or disclosed without the authorized written consent of Osage Ambulances.</p> |  | Drawn By: S.A.H.  | Date: 04-25-23     |
| <p>Scale: NOT TO SCALE</p>   |  | <p>Revision#</p>  |                    |
| <p>CONSOLE DRAWING,<br/>HIGH-ROOF TRANSIT</p>  |  | <p>1</p>          |                    |